



操作说明书
Instruction Manual

PS 8000 T
Laboratory Power Supply



PS 8016-20T: 09 200 120
PS 8032-10T: 09 200 121
PS 8065-05T: 09 200 122
PS 8032-30T: 09 200 123
PS 8065-10T: 09 200 124

PS 8160-04T: 09 200 125
PS 8080-40T: 09 200 126
PS 8080-60T: 09 200 127
PS 8360-10T: 09 200 128
PS 8360-15T: 09 200 129



关于

Elektro-Automatik GmbH & Co. KG

Helmholtzstrasse 31-33

41747 Viersen

Germany

电话: +49 2162 / 37850

传真: +49 2162 / 16230

网址: www.elektroautomatik.cn

邮箱: ea1974@elektroautomatik.cn

© Elektro-Automatik

严禁翻版、复制或部分错误地使用该说明书，否则将承担相应的法律后果。

有生命危险!

危险电压

本产品输出电压可能上升至危险级别 (>60V_{DC})!

产品上所有带电元件必须有外遮盖。输出端的所有操作必须在产品与主电源（电源开关关闭）断开时才能执行，且可只有受过训过电流危险知识的专业人员执行此类操作。负载与本产品间的任何连接必须有防碰擦装置。连到功率输出端的应用设备必须配置好，并且有保险丝熔断保护，这样可防止使用过程中由于过载或误操作损坏产品或更严重事情发生。

注意!

产品或输出关闭后，直流输出端在一定时间内仍存在危险电压!

请谨记

- 请仅在铭板标示电压下操作本产品。
- 请勿将任何机械零件，特别是金属件，插入通风孔内。
- 请不要在本产品周围使用任何液体物质，以免进入产品内。
- 请勿将高于电源供应器额定电压的电压源连接到产品上。
- 从后板插槽安装接口卡时，请遵循一般防静电规则。
- 只能在产品完全关闭（电源开关为关闭状态）后插入和取出接口卡。
- 产品老化以及超负荷使用都可能导致如按钮、旋钮类的产品控制件操作不稳定。
- 请勿将电压源反接到直流输出端！产品可能会被损坏。
- 请勿将那些可能会产生高于产品额定电压的电压源连到直流输出端！

	页码
1. 介绍.....	5
2. 技术规格.....	5
2.1 控制面板和显示器.....	5
2.2 各型号详细规格.....	6
3. 产品描述.....	7
3.1 前视图.....	7
3.2 其它视图.....	8
3.3 供应清单.....	9
4. 一般信息.....	9
4.1 序言/ 安全警告.....	9
4.2 制冷.....	9
4.3 拆开产品.....	9
5. 安装.....	9
5.1 目检.....	9
5.2 与市电的连接.....	9
5.3 直流输出端.....	9
5.4 “感测”端 (远程感测).....	9
5.5 接口卡插槽.....	9
6. 操作.....	10
6.1 显示器.....	10
6.2 控制面板各按钮说明.....	10
6.2.1 Preset V/C/OVP按钮.....	10
6.2.2 Memory M1...M5按钮.....	10
6.2.3 Fine/Setup按钮.....	10
6.2.4 Lock/Local按钮.....	11
6.2.5 Output on按钮.....	11
6.3 其它控制键.....	11
6.3.1 Standby按钮.....	11
6.4 调节设定值.....	11
7. 产品特性.....	12
7.1 用电源开关打开.....	12
7.2 用电源开关关闭.....	12
7.3 激活待机模式.....	12
7.4 转至远程控制模式.....	12
7.5 过压报警.....	12
7.6 过温报警.....	12
7.7 调整电流或电压.....	12
7.8 远程感测.....	12
7.9 市电出现欠压或过压.....	12
7.10 连接不同类型的负载.....	12
8. 产品设置.....	13
9. 数字接口卡.....	14
10. 模拟接口.....	14
10.1 一般信息.....	14
10.2 应用举例.....	15
10.3 模拟接口各引脚分布.....	16
11. 其它.....	17
11.1 其它附件和选项功能.....	17
11.2 并联.....	17
11.3 串联.....	17
11.4 固件更新.....	17

1. 介绍

PS 8000T系列是结构紧凑、坚固耐用的实验室电源，在如此小体积下却具备多项有趣特征。

除电源产品的标准功能外，用户还可定义和恢复5组不同的预设值，或使用可在0...5V或0...10V普通电压范围内工作的内置模拟接口。

还提供一种简易的监控本产品或完全程控制方法。还可选择数字接口卡，通过电脑实现更宽光谱范围的控制和监控功能。

通过接口卡的使用可轻易地将产品整合于现有系统内，且根本不需配置接口卡或仅需配置少数设定值。

本产品通过接口卡可连接其他类型电源，并借此控制它们。或者通过外置控制系统，如PLC-可编程控制器，对本产品进行控制和监测。

本产品由微处理器控制，得以使之能准确、快速地测量并显示各实际值。

塔式结构的设计实现了节省空间的同时，又能适合复杂和高性能的应用。例如：应用于研发或教育领域，具有可变功率以进行不同演示或测试的工业化测试设备。

主功能一览：

- 0...100%范围内的设定电压和电流
- 0...110% U_{Nom} 可调过压门限
- 插拔式接口卡 (CAN, USB, RS232, IEEE/GPIB, Ethernet/LAN, Profibus)
- 外部控制和监测用模拟接口，用0...5V或0...10V (可选)控制0...100%的范围值
- 功率级别：320W, 640W, 1000W和1500W
- 温控风扇
- 状态(OT, OVP, CC, CV) 指示灯
- 待机模式
- 5种可选内存集
- Vector™兼容的CAN系统
- 免费的Windows软件
- LabView™ VIs

2. 技术规格

2.1 控制面板和显示器

型号

显示器： LED式7段显示器，4位数，加逗号

旋钮： 2个旋钮，6个按钮

显示格式

额定值限定最大可调范围。

电压和电流实际值和设定值同时显示，过压门限设定值则分开显示。

电压的显示

分辨率： 4位数

格式： 0.00V...99.99V

0.0V...999.9V

电流的显示

位数： 4

分辨率： 最大 $\pm 0.2\%$ of I_{nom}

格式： 0.000A...9.999A

0.00A...99.99A

2.2 各型号详细规格

	PS 8016-20 T	PS 8032-10 T	PS 8065-05 T	PS 8032-20 T	PS 8065-10 T	PS 8160-04 T	PS 8080-40 T	PS 8360-10 T	PS 8080-60 T	PS 8360-15 T
电源输入										
输入电压	90...264V AC	90...264V AC	90...264V AC	90...264V AC	90...264V AC	90...264V AC	90...264V AC	90...264V AC	90...264V AC	90...264V AC
频率	45...65Hz	45...65Hz	45...65Hz	45...65Hz	45...65Hz	45...65Hz	45...65Hz	45...65Hz	45...65Hz	45...65Hz
保险丝	T 4A	T 4A	T 4A	T 8A	T 8A	T 8A	T 16A	T 16A	T 16A	T 16A
功率因数	> 0.99	> 0.99	> 0.99	> 0.99	> 0.99	> 0.99	> 0.99	> 0.99	> 0.99	> 0.99
浪涌电流	< 25A	< 25A	< 25A	< 25A	< 25A	< 25A	< 25A	< 25A	< 25A	< 25A
输出关闭时的功率损耗	12W	12W	12W	12W	12W	12W	31W	31W	31W	31W
待机时的功率损耗	7W	7W	7W	7W	7W	7W	11W	11W	11W	11W
输出 - 电压										
额定电压 U_{nom}	16V	32V	65V	32V	65V	160V	80V	360V	80V	360V
可调节范围	0V... U_{nom}	0V... U_{nom}	0V... U_{nom}	0V... U_{nom}	0V... U_{nom}	0V... U_{nom}	0V... U_{nom}	0V... U_{nom}	0V... U_{nom}	0V... U_{nom}
市电波动范围在 $\pm 10\% \Delta U_{in}$ 时的稳定度	< 0.02%	< 0.02%	< 0.02%	< 0.02%	< 0.02%	< 0.02%	< 0.02%	< 0.02%	< 0.02%	< 0.02%
带载 10...90% 时的稳定度	< 0.05%	< 0.05%	< 0.05%	< 0.05%	< 0.05%	< 0.05%	< 0.05%	< 0.05%	< 0.05%	< 0.05%
纹波 HF BWL 20MHz	< 40mV P-P	< 100mV P-P	< 150mV P-P	< 100mV P-P	< 150mV P-P	< 120mV P-P	< 10mV P-P	< 30mV P-P	< 10mV P-P	< 50mV P-P
纹波 LF BWL 20MHz	< 4mV RMS	< 10mV RMS	< 20mV RMS	< 8mV RMS	< 10mV RMS	< 20mV RMS	< 4mV RMS	< 11mV RMS	< 4mV RMS	< 8mV RMS
精度*	$\leq 0.2\%$	$\leq 0.2\%$	$\leq 0.2\%$	$\leq 0.2\%$	$\leq 0.2\%$	$\leq 0.2\%$	$\leq 0.2\%$	$\leq 0.2\%$	$\leq 0.2\%$	$\leq 0.2\%$
显示器分辨率	10mV	10mV	10mV	10mV	10mV	100mV	10mV	10mV	10mV	100mV
远程感测补偿	max. 2V	max. 2V	max. 2V	max. 2V	max. 2V	max. 2V	max. 2.5V	max. 8V	max. 2.5V	max. 8V
过压保护门限 (可调)	0...17.6V	0...35.2V	0...71.5V	0...35.2V	0...35.2V	0...176V	0...88V	0...396V	0...88V	0...396V
输出 - 电流										
额定电流 I_{nom}	0...20A	0...10A	0...5A	0...20A	0...10A	0...4A	0...40A	0...10A	0...60A	0...15A
可调节范围	0A... I_{nom}	0A... I_{nom}	0A... I_{nom}	0A... I_{nom}	0A... I_{nom}	0A... I_{nom}	0A... I_{nom}	0A... I_{nom}	0A... I_{nom}	0A... I_{nom}
市电波动范围在 $\pm 10\% \Delta U_{in}$ 时的稳定度	< 0.05%	< 0.05%	< 0.05%	< 0.05%	< 0.05%	< 0.05%	< 0.05%	< 0.05%	< 0.05%	< 0.05%
带载 0...100% ΔU_{OUT} 时的稳定度	< 0.15%	< 0.15%	< 0.15%	< 0.15%	< 0.15%	< 0.15%	< 0.15%	< 0.15%	< 0.15%	< 0.15%
纹波 HF BWL 20MHz	< 60mA P-P	< 35mA P-P	< 12mA P-P	< 65mA P-P	< 25mA P-P	< 3mA P-P	< 19mA P-P	< 1mA P-P	< 19mA P-P	< 1mA P-P
纹波 LF BWL 20MHz	< 10mA RMS	< 7mA RMS	< 3mA RMS	< 10mA RMS	< 3mA RMS	< 1mA RMS	< 7mA RMS	< 0.45mA RMS	< 7mA RMS	< 0.45mA RMS
精度*	$\leq 0.2\%$	$\leq 0.2\%$	$\leq 0.2\%$	$\leq 0.2\%$	$\leq 0.2\%$	$\leq 0.2\%$	$\leq 0.2\%$	$\leq 0.2\%$	$\leq 0.2\%$	$\leq 0.2\%$
显示器分辨率	10mA	10mA	1mA	10mA	10mA	1mA	10mA	10mA	10mA	10mA
负载从 10...90% 跃变用时	< 2ms	< 2ms	< 2ms	< 2ms	< 2ms	< 2ms	< 2ms	< 2ms	< 2ms	< 2ms
输出 - 功率										
额定功率 P_{nom}	320W	320W	325W	640W	640W	640W	1000W	1000W	1500W	1500W
额定功率 $< 150V U_{in}$	320W	320W	325W	640W	640W	640W	1000W	1000W	1000W	1000W
其它										
工作温度	0...40°C	0...40°C	0...40°C	0...40°C	0...40°C	0...40°C	0...40°C	0...40°C	0...40°C	0...40°C
储存温度	-20...70°C	-20...70°C	-20...70°C	-20...70°C	-20...70°C	-20...70°C	-20...70°C	-20...70°C	-20...70°C	-20...70°C
相对湿度	< 80%	< 80%	< 80%	< 80%	< 80%	< 80%	< 80%	< 80%	< 80%	< 80%
尺寸 (WxHxD)	90x240x280mm	90x240x280mm	90x240x280mm	90x240x280mm	90x240x280mm	90x240x280mm	90x240x395mm	90x240x395mm	90x240x395mm	90x240x395mm
重量	3.8kg	3.8kg	3.8kg	3.8kg	3.8kg	3.8kg	6.5kg	6.5kg	6.5kg	6.5kg
安全标准	EN 60950									
EMC标准	EN 61000-6-4, EN 55022 等级 B									
过压等级	等级 II									
保护等级	等级 I									
产品编号	09200120	09200121	09200122	09200123	09200124	09200125	09200126	09200128	09200127	09200129

* 与额定值相关

3. 产品描述

3.1 前视图

关于旋钮、按钮和端子的描述:

1) 功率输出安全插座，带极性

用于配4mm的Bueschel插头或铲型接线夹片。

⚠ 注意!

对于1000W和1500W型号产品，直流输出端的4mm前板插座最大仅能承受32A的电流!

2) 程感测输入插座，带极性

按正确极性将程感测线连接于此。详情请参考章节7.8。

3) 模拟接口，15引脚，D-Sub型，母座

可将模拟信号转为数字信号，进而程控制和监测产品。详情请参考章节„10. 模拟接口“。

4) “Standby-待机”按钮

可将产品转至待机状态和恢复普通操作模式。

5) 旋钮，向右，无中断点

用于调节输出电流设定值。

约5个整圈相当于0...100%的范围。

在设置菜单下，用它可调节各项设定。

也可参考章节„6.4 调节设定值“和„8. 产品设置“。

6) 旋钮，向左，无中断点

用于在预设模式下调节输出电压设定值，也可调节OVP门限。

约5个整圈相当于0...100%的范围。

在设置菜单下，用它可选择参数。

也可参考章节„6.4 调节设定值“和„8. 产品设置“。

7) 控制面板和显示屏



图 1

3.2 其它视图



图 2

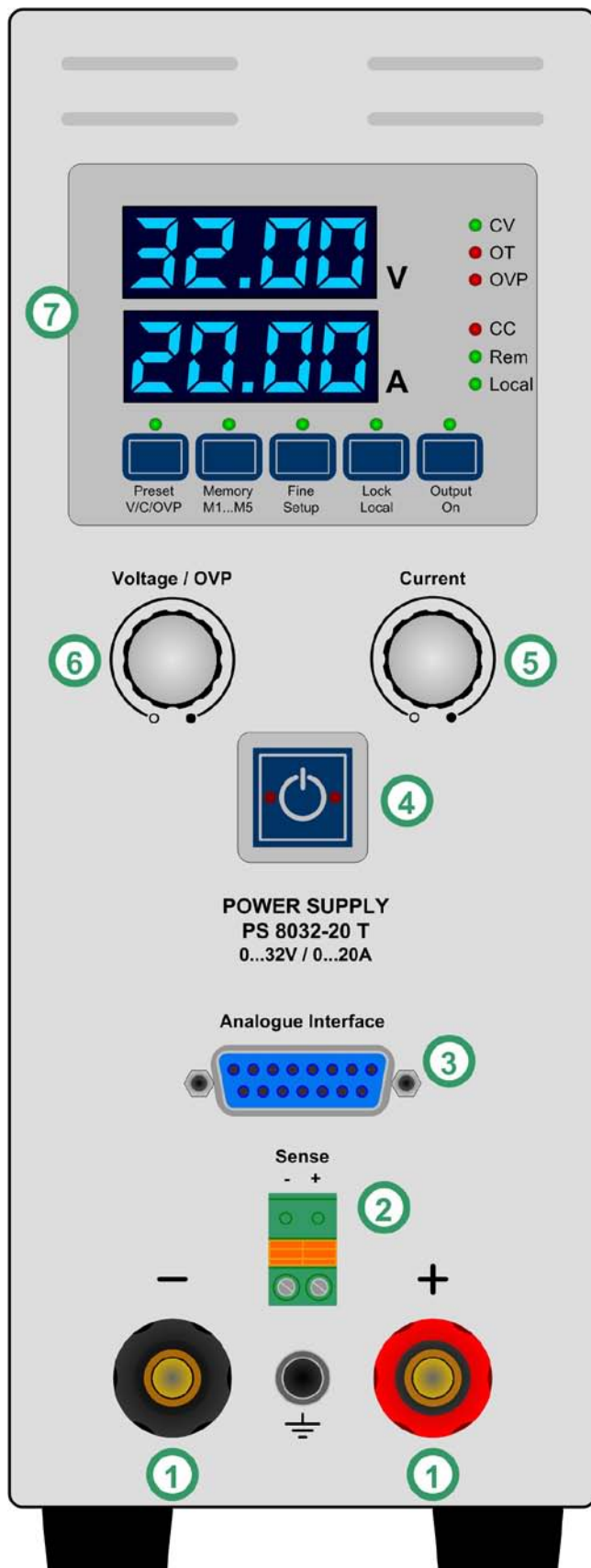

图 3

3.3 供应清单

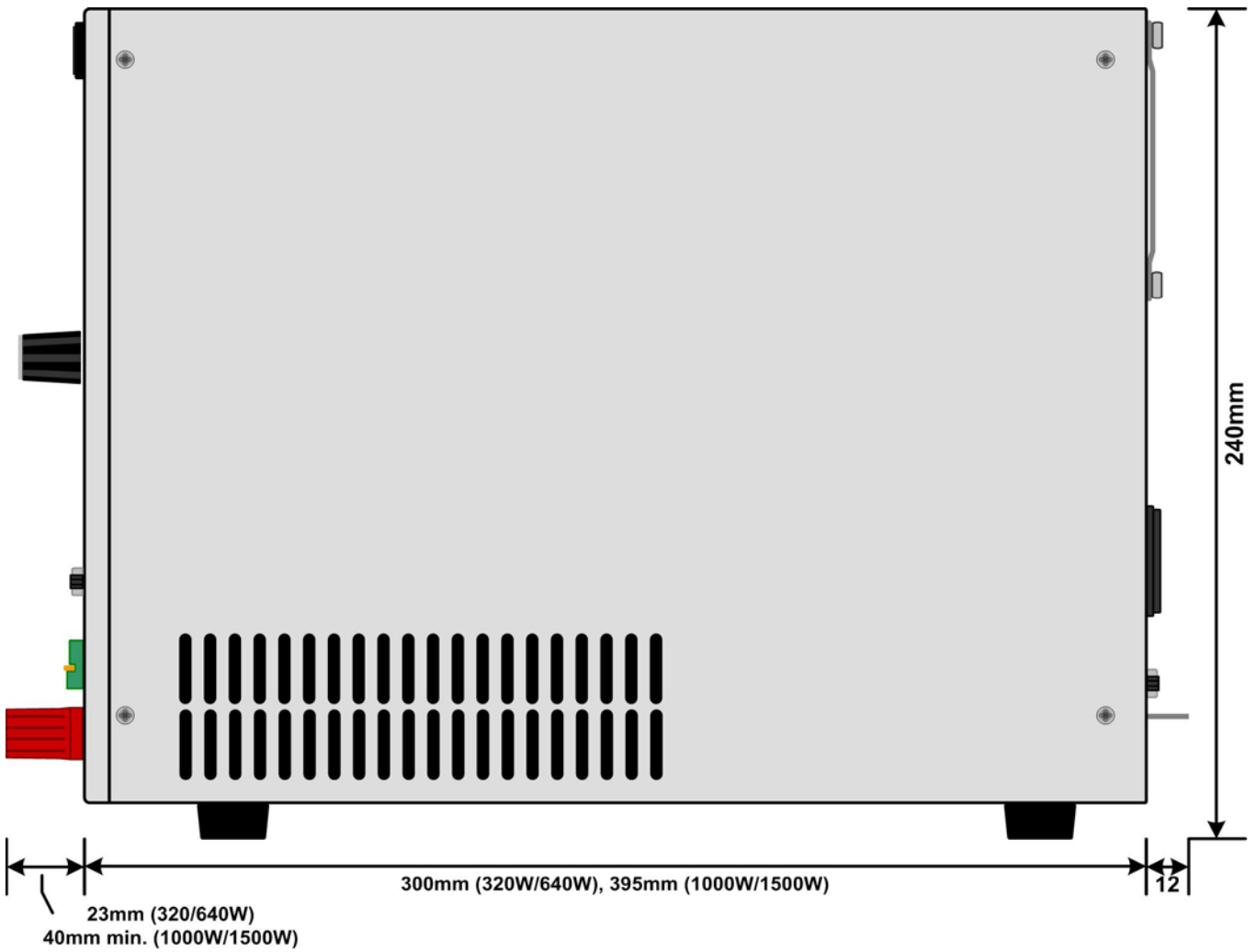
- 1 x 电源供应器
- 1 x 印刷版使用说明书
- 1 x 电源线

4. 一般信息

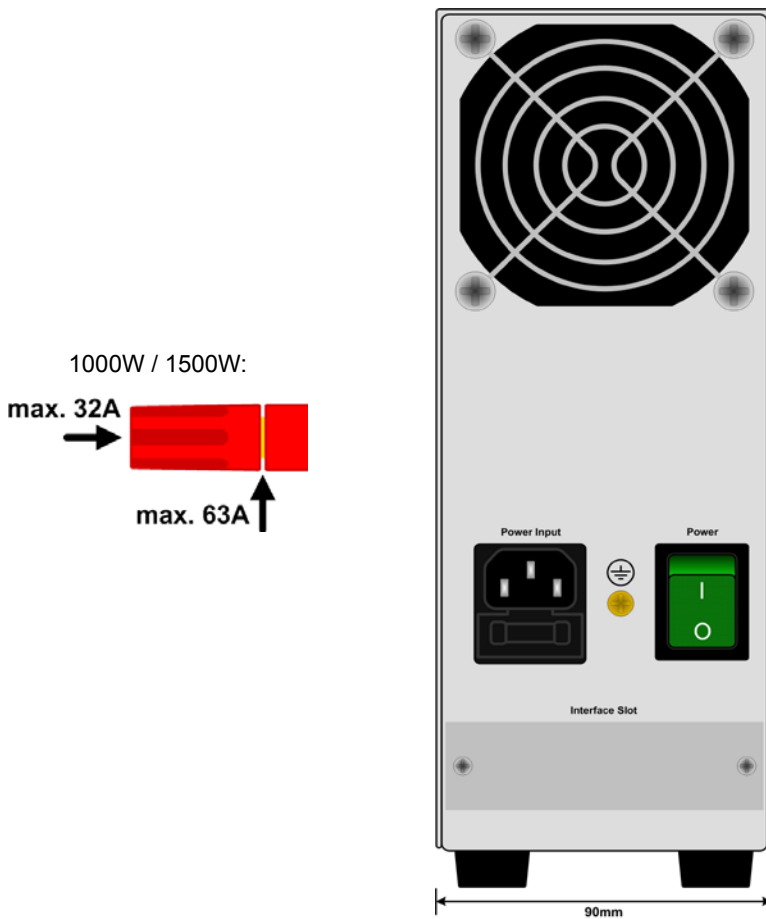
4.1 序言/ 安全警告

本说明书和产品专给对电源有基本了解的人士使用。不应给无基本电器知识的人士操作，因本说明书未作此方面描述。操作不当和未遵守安全说明的操作，可能会损坏产品或丧失产品保修权！

4.2 制冷

要保持外壳两侧进风孔和后板排风孔的清洁，以确保良好的冷却效果。注意产品后方至少10cm以内无任何物体阻挡，以保障空气流通顺畅。

4.3 拆开产品

若想拆开产品或用工从产品内部拆除零件，可能会有高压触电的危险。必须将本产品与主电源断开后方可进行，否则用户自行承担风险。

仅受过电流危险知识训练的人员方可进行相关的维护或修理。

5. 安装

5.1 目检

收到本产品后，请检查是否有外观受损痕迹。如有，请不要操作本产品，应立即联系您的供应商。

5.2 与市电的连接

本产品通过电源线接地。故仅可与带接地触点的电源插座相连。且连线中间不可接无接地触点的延伸线！

还装有5x20mm的保险丝(具体数值请看规格参数表)，从电源插座内可拆装更换。

5.3 直流输出端

功率输出端位于产品前部。

本输出端无保险！为避免损坏负载设备，应随时注意负载机的额定值。

连接线的直径取决于多个条件，像输出电流、线长和环境温度。

建议使用长为1.5m的连线：

5A 以下：	0.5mm ² ，	10A 以下：	0.75mm ²
15A 以下：	1.5mm ²	20A 以下：	2.5mm ²
40A 以下：	6mm ²	60A 以下：	16mm ²

针对**每根线**(弹性线)。

输出“+”和“-”极未接地，若有必要，可将其中一极接地。

注意！

将其中一输出极接地时，请随时检查负载(如电子负载)的其中一极是否也已接地。否则将引起短路！

注意！

串联时注意输出极的电位转移！此时仅建议带最低电位的极点接地。

注意！

对于1000W和1500W型号产品，直流输出端的4mm前板插座最大仅能承受32A的电流！

5.4 “感测”端(远程感测)

为补偿负载线上(每根线最大1V)的压降，电源可“感测”负载端而不是输出端的电压。它将调整输出电压以使负载获得所需电压。

按正确极性将程感测线连到Sense-感测端。

注意！

(+) 感测端只能与负载设备(+)端相连，(-)感测端与(-)端相连！否则会损坏两头的产品。

详情也可参考章节7.8。

5.5 接口卡插槽

可选择给本产品配上接口卡。接口卡插槽位于产品后端。更多信息见章节„9. 数字接口卡“。

6. 操作

6.1 显示器

图4展示了LED显示器，LED灯和控制面板的总图。正常操作时，显示器显示实际电压（上排）和电流（下排）。在预设模式下显示设定电压或过压保护值（上排）和设定电流值（下排）。而在设置模式下，上排显示所选参数，下排为相关设置。

LED状态灯（右边）指示如下：

CV - 电压调整启动 (只有当输出为“on”时)

OT - 过温错误

OVP - 过压错误

CC - 电流调整启动 (只有当输出为“on”时)

Rem - 程控制启动(数字或模拟)

Local - LOCAL模式启动



图 4

6.2 控制面板各按钮说明

6.2.1 Preset V/C/OVP按钮

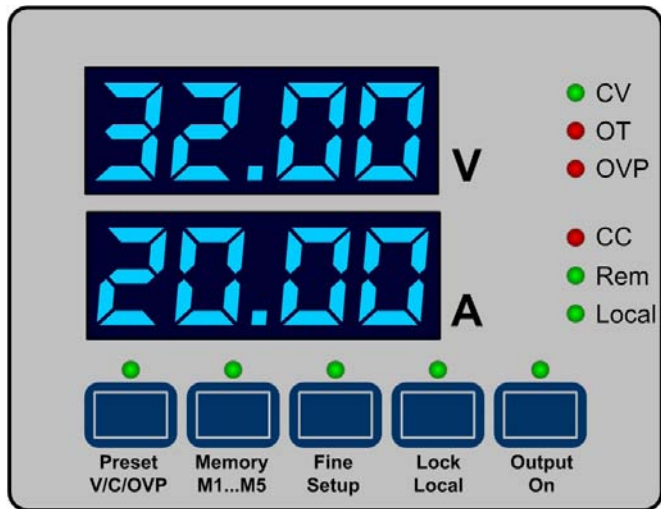
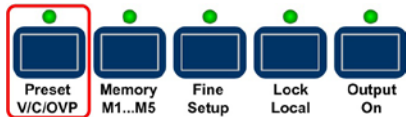

用这个按钮可转为设定值显示，即：预设模式。按一下，显示电压和电流的设定值，按两下，显示过压保护设定值（门限）。为了便于区分，在显示器的下方会显示“OVP”文本。按钮上方的LED灯指示预设模式。用这两个旋钮都可调节0...100%的 U_{Max} 或 I_{Max} 设定值，或0...110%范围的 U_{Max} 值（即OVP-过压保护值）。这些数值会被立即提交到输出端。

按三下，则退出预设模式。如果超过5秒仍未更改任何设定值，也自动结束该操作。

借模拟或数字接口进行远程控制期间，该按钮用于显示由控制接口最新设置的设定值。用模拟接口控制时，不可从外部调节OVP门限，故显示器只显示最小调节值。

通过**LOCK**状态可锁定该按钮，见6.2.4详述。

6.2.2 Memory M1...M5按钮

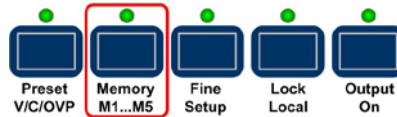

该按钮有两个功能：一是从五个内存集中选择一个提交，或者让存储这些内存集。提示：该按钮仅当**输出关闭**后才工作。内存模式由按钮上的LED灯指示出来。

可执行的操作：

a) 选择和提交

输出关闭，按一下按钮，显示器首先展示内存集1（M1），如下短暂显示设定号：



接着显示电压(上排)和电流(下排)设定值。如预设模式下一样，按下**Preset V/C/OVP**按钮即转换为OVP设定值。

再按一下**Memory M1...M5**按钮，五个内存集滚动显示，然后退出。

b) 仅提交

输出关闭，选择内存集(1-5)，按**Output On**按钮 --> 所选内存集的设定值提交至产品输出端，于是打开输出。

提示

如果有更改，此操作不会保存选定的内存集。

c) 仅存储

输出关闭，选择一个内存集，按需求调节数值，按住**Memory M1...M5**按钮不放，保持3秒以上时间 --> 所有内存集被保存，但不会被提交。输出仍为关闭状态，内存集保存后将退出内存模式。

也可利用数字接口（经GPIB和以太网接口，利用SCPI指令语言操作除外）通过远程控制和相应指令来定义内存集，并被即时存储。

本按钮可在**LOCK**状态下锁定，见6.2.4详述。

6.2.3 Fine/Setup按钮

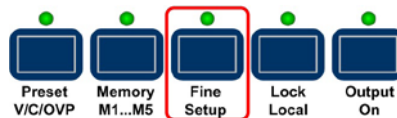

此按钮有两功能：一是可在设定值调节模式，**细调**和**粗调**间转换，另一个是激活设置模式。

可执行的操作：

a) 短按 --> 打开/关闭细调模式。激活的“细调”模式通过该按钮上的LED灯指示出来。在该模式下所有设定值可按最可能小的步宽（最后1位数）来调节。终止细调模式即转为粗调。也可参考章节“6.4 调节设定值”。

b) 输出关闭，长按>3s --> 产品转为设置模式。详情请参考“8. 产品设置”。所有设定完成后，再次长按按钮>3s --> 退出产品设置，保存设定值，且按钮上面的LED灯闪烁三下。

本按钮可在**LOCK**状态下锁定，见6.2.4详述。

6.2.4 Lock/Local按钮

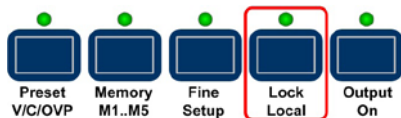

本按钮有两个功能：激活/终止控制面板锁定或LOCAL模式。

提示

激活LOCAL模式会即刻从远程控制模式退出，并不再允许继续远程控制产品，除非再次退出LOCAL模式。

可执行的操作：

a) 快按 --> 打开/关闭LOCK 意思是，它会锁定所有按钮，除LOCK按键和旋钮外。LOCK模式通过按钮上的LED灯指示。锁定控制面板可防止无意使用按钮和编码器。

b) 长按>3s (只要LOCK未启用) --> 打开/关闭LOCAL。在“on”状态下，产品转为手工操作。意思是只要LOCAL为激活状态，本产品既不可通过模拟或数字接口远程控制。打开LOCAL将立即退出任一遥控状态。工作中的LOCAL模式由Local灯指示。

提示

LOCK状态被保存，只有打开产品后才可恢复（仅针对6.03以后固件版本的产品）

6.2.5 Output on按钮

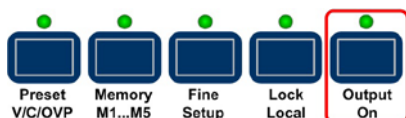

此按钮手动打开或关闭电源输出，只要产品未处于遥控模式。输出状态通过按钮上面的LED灯指示出来。输出打开时，调整模式(CC或CV)对应的LED灯亮。输出关闭时，两LED灯也全部关闭。

此按钮也可在LOCK状态下锁定。见6.2.4详述。

输出的打开可通过模拟接口的13脚(REM-SB)来阻止。见章节„10. 模拟接口“。

它还可识别OVP报警信息。若出现过压，且原因消除或清除后，“OVP”灯仍亮，直到用该按钮确认该报警信息。

6.3 其它控制键

6.3.1 Standby按钮



激活或终止待机模式。按下该按钮，取消任何当前模式，整个显示屏被关闭。

产品会“记住”最后的输出状态与设定值，当它由待机回到正常操作时，产品会回退到那个输出状态下。该功能同样适用于当用电源开关关闭产品或市电突然断电的情形，此时产品处于待机状态。

注意!

如果转为待机时产品设置处于激活状态，则不保存任何更改的设定!

6.4 调节设定值

1. 手工操作

在手工操作下，两旋钮可按预定幅度（见下）在0%至100%的额定电压和电流设定值间连续调节。在预设模式下，OVP门限可在0%至110%的额定电压间调节。若想调节OVP，需接两下Preset VIC/OVP按钮。

OVP门限可低于电压设定值！只要实际电压超过OVP门限，它即刻产生OVP错误并关断输出，或阻止打开输出。

通过手工细调或粗调可完成设定值的设置，默认状态下为粗调。需要细调时要按细调按钮来激活，幅度为1。

粗调则按额定值的下列步宽来进行（也可参考技术规格）：

电压 / OVP		电流	
额定值	步宽	额定值	步宽
16V	0.1V	4A	0.05A
32V	0.2V	5A	0.05A
65V	0.5V	10A	0.1A
80V	0.5V	15A	0.1A
160V	1V	20A	0.2A
360V	2V	40A	0.5A
		60A	0.5A

提示

对于有些产品，设定值的可调步宽可以小于产品实际传输到输出端的步宽，故输出电压可能只会每到第三步才每秒钟反应一次。

2. 通过模拟接口远程控制

请参考章节„10. 模拟接口“。

3. 通过数字接口远程控制

请参考章节„9. 数字接口卡“。

7. 产品特性

7.1 用电源开关打开

电源开关位于产品后端。打开产品后即可工作。有一选项，决定产品打开后电源输出和设定值的状态。默认状态下，该选项被激活（on），意思是产品在被电源开关关闭后，它将保存最后的输出状态，包括设定值，再一次启动后恢复为该状态。

如果该选项被停用（off），U和I的设定值为0，每次启动后都打开输出。

7.2 用电源开关关闭

用电源开关关闭产品如电源断电一样。它会保存最后的设定值和输出条件。短时间过后，功率输出和风扇关闭，几秒钟后，产品完全关闭。

7.3 激活待机模式

如果待机按钮激活待机模式，产品会像用电源开关关闭产品一样操作。是恢复输出条件还是设为默认值，取决于产品设置下“P on”选项的设定。

7.4 转至远程控制模式

a) **模拟接口**: 如果产品没被LOCAL模式限制，或早已经数字接口激活远程模式，“Remote”引脚通过VSEL (1), CSEL (2), 以及REM-SB(13)引脚的设定值，将产品转为模拟远程控制。输出状态和设定值即刻被设置。从远程控制回到手动控制模式后，输出被自动关闭。

b) **数字接口**: 如果产品没被LOCAL模式限制，或早已经模拟接口激活远程控制，通过相关指令（此处为：对象）转为数字远程控制，并保留输出状态和设定值，直至被更改。退出远程控制，会自动关闭输出。

7.5 过压报警

过压报警可以因内部缺陷（输出电压上升且不可控）或外部电压太高而引起。过压保护(OVP)将关闭输出，并以“OVP”LED灯和AI上的“OVP”引脚指示此错误。

如果清除过压原因，输出会再次打开，但需先确认此报警信息。在手工操作模式下，以按下**Output On**按钮为确认方式，在模拟遥控模式下是“REM-SB”引脚，而在数字遥控模式下为相关指令。“OVP”LED灯和引脚只是定不在指示报警。如果报警仍然存在，不打开输出。

OVP报警以报警声记录于内部警报器。通过数字接口可读取。

7.6 过温报警

一旦由于内部过热而出现过热(OT)报警，则关断输出，且LED“OT”灯亮。同时**Output On**按钮上的灯会闪烁，指示出产品一旦冷却后即自动重启。如果不想这样，可手工关闭输出。LED灯停止闪烁，输出就不会自动启动。

OT报警要被确认。如果产品在冷却后还是关闭的，可使用**Output on**按钮或**Output on**引脚或相关指令来打开。如果输出为打开状态，可按一下**Output on**按钮，或给“REM-SB”引脚一由高至底的触发，或使用相关指令，来关闭输出。

OT报警以报警声记录于内部警报器。通过数字接口可读取，除非使用的是SCPI指令语言。

7.7 调整电流或电压

负载的输出电压和阻值决定输出电流。只要输出电流低于调整后设定电流值，产品以恒压(CV)模式操作。且以“CV”灯指示出来。

输出电流被设定电流或产品的额定电流限制，从而转为恒流(CC)模式。且以“CV”灯指示出来。

7.8 远程感测

程感测操作用来补偿电源和负载间连线的压降。因为这受限于一定水平，建议按照输出电流选择适当直径的连线，以将压降减到最小。产品前板装有一感测端子，可按正确极性连线到此。

电源会自动检测外部感应端，并通过负载的实际电压而非输出电压，来补偿输出电压，从而按照电源与负载间的压降值提升输出电压。

最大补偿值：每根线为1V。



图5. 感测线的连接

7.9 市电出现欠压或过压

本产品的特征为采用主动式功率因素和宽范围的输入。意为，可在90V..264V输入电压下操作。低于90V的输入电压被认为产品已被关闭，从而它会保存最后的条件，然后关断功率输出。

注意!
应避免输入端长期欠压或过压!

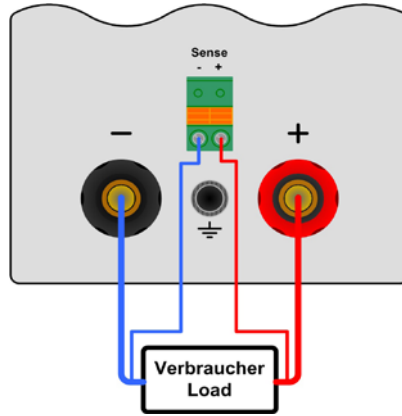
提示
1500W功率的产品在输入电压低于约150V时降额至1000W。

7.10 连接不同类型的负载

不同类型的负载，如阻性负载（台灯，电阻），电子负载或感性负载（马达），性能不同，它们会对电源起反作用。例如，马达会产生一反电压，导致电源因过压保护而关断输出。

电子负载有电压、电流和功率调整线路，他们与电源相互作用，可能会提高输出纹波或其它多余的副作用。电阻负载几乎100%中性。故建议在安排应用时要考虑负载的特性。

8. 产品设置

产品设置目的在于设定不常变动的参数。通常有两个基本设置，其它设定仅在配上数字接口卡时才需要。

只有关闭输出，长按**Fine/Setup**按钮超过**2s**，才可进入产品设置。当再次退出产品设置时，该按钮上的LED会闪烁3下，以指示出设定值已提交并被存储进去。

若更换成一不同于数字接口卡的卡时，产品仍保留数字接口的所有设置不变。故用户不必每次更换接口卡类型时都设置一次。

具体有下列基本设置：

参数: **P on** 默认: **on**

设置: **on, off**

解释: 为“on”时，在产品关闭或停电前保存最后状态。这可保证产品在恢复电源后可继续按最后的设定操作。

参数: **Ri** 默认: **0-10**

设置: **0-5, 0-10**

解释: 通过模拟接口选择使用的电压范围。也可见章节7.1。

参数: **brtn** 默认: **1**

设置: **1..4**

解释: LED显示器亮度调整（1 =最低）

适用于**所有**接口卡：

参数: **node** 默认: **1**

设置: **1..30**

解释: 选择产品位址（产品节点，CAN的专业术语）。当将产品应用于总线系统(CAN或GPIB)时，每台产品必须有一独特的地址！

参数: **Info**

解释: 如果安祖昂有接口卡，则显示接口卡的相关信息。且多次显示。下部分显示：

1. 接口卡类型缩写，如：IF-C1 (CAN 卡)缩写成 „C 1“
2. 接口卡的固件版本，如果插有接口卡的话，没有则显示 „----“

利用**CAN接口卡-IF-C1**才可进行下列设置：

参数: **IdSY** 默认: **Std**

设置: **Std, dbC**

解释: 选择CAN ID系统 (IDSY)。“Std”指标准，利用两个由 „node“（如上）和 „RID“（如下）创建起来的CAN IDs选择之前的CAN ID系统。也可见接口卡操作说明书，关于CAN IDs是如何由设置参数计算出来的。

其它系统则每台产品使用三个CAN IDs，并与Vector信息软件和所谓的DBC文件兼容。若选择了该系统，用户需调节一基本ID，来定义赋予产品的三个IDs。见下面。

参数: **bAud** 默认: **100**

设置: **10, 25, 50, 100, 125, 250, 500, 1000**

解释: 选择CAN传输波特率。

参数: **r Id** 默认: **0**

设置: **0..31**

解释: 选择重定位识别段(RID)。可参考CAN专业术语或IF-C1 CAN接口卡的说明书，查阅更多信息。

参数: **bA Id** 默认: **000**

设置: **000..7FC**

解释: 通过三个IDs (Vector兼容, DBC文件) 来定义CAN ID系统的基本ID (BAID)。根据调整后的基本ID，这三个IDs预留给一台产品。因此只有在第四步时才能调节这些参数。且仅以十六进制值显示。

只有当 **IdSY = dbC** 被选定后方出现这个参数，如上。

参数: **bC Id** 默认: **7FF**

设置: **000..7FF**

解释: 通过三个IDs (Vector兼容, DBC文件) 来调节CAN ID系统的广播ID (BCID)。这个ID是产品用来给同一总线上的多台产品广播信息的第四个ID。仅以十六进制值显示。目的在于所有产品的这个ID调节成相同值，从而可通过设定值或产品状态同时控制这些产品。

只有当 **IdSY = dbC** 被选定后方出现这个参数，如上。

参数: **bCEr** 默认: **on**

设置: **on, off**

解释: 启用/停用CAN接口卡的总线终止电阻。这只有在产品位于产品终端时才需要。

利用**RS232接口卡-IF-R1**才可进行下列设置：

参数: **bAud** 默认: **576**

设置: **96, 192, 384, 576**

解释: 选择以波特率为单位的串行传输速率。即：96表示9600波特，576为57600波特。利用RS232不可配置其它参数，但可这样使用：

奇偶性 = 奇数

停止位 = 1

数据位 = 8

必须设置成相同于电脑的配置。

利用**Profibus接口卡-IF-PB1**才可进行下列设置：

参数: **PbAd** 默认: **1**

设置: **1..125**

解释: 定义产品的Profibus地址。该地址与产品节点分开使用，以便执行并访问现场总线系统下的产品。

9. 数字接口卡

本产品支持下列插拔式接口卡：

IF-U1 (USB)

IF-R1 (RS232)

IF-C1 (CAN)

IF-G1 (GPIB/IEEE)

IF-E1/IF-E1B (Ethernet/LAN + USB)

IF-PB1 (Profibus)

IF-R1 (RS232), IF-C1(CAN) 和 IF-U1(USB) 数字接口卡使用统一的通讯协议。利用此类卡在一台电脑上可一次控制多至30台产品。

IF-G1 (IEEE 488) GPIB接口卡给每个总线上多达15产品提供一个SCPI指令结构。IF-A1模拟接口卡为电隔离形式，其模拟接口配有可配置输入和输出端。

Ethernet/LAN接口IF-E1和IF-E1B也配有指令集。其特征为它有一额外的USB端口，故而能像IF-U1卡一样操作产品。

产另外还有一种接口卡--IF-PB1，能实现Profibus-现场总线连接。

这些卡插入产品后仅需进行少数设置或不需任何设置。即使替换成另外一不同类型卡，仍能保留前一张卡的具体设置。因此不用每次插入一张卡就设置一次。

关于接口卡的详细技术规格和操作，以及将产品应用于总线系统的说明，或用电脑(LabView等)控制产品，都可在IF卡用户操作说明书中找到。

注意！

仅在产品被完全关闭（用电源开关）后才可插入或取出接口卡！

关于插拔式接口卡的配置请看章节„8. 产品设置“。

数字接口允许电脑设置电压和电流，以及OVP门限。当转为远程控制模式时，产品保留最后的设定值，直至被更改。因此可传送任意的设定值仅用来控制电压，而电流值保持不变。

数字接口（除GPIB外）传输的设定值永远为百分数，对应100% (hex: 0x6400)的额定值，或110%(hex: 0x6E00)的OVP门限。

另外，数字接口卡允许查询和设定大量其它功能和数值。

10. 模拟接口

10.1 一般信息

15脚模拟接口位于产品前端，提供下列功能：

程控制电流和电压

- 程监控(OT, OVP, CC, CV)状态
- 程监控实际数值
- 程打开/关闭输出

模拟接口(AI)允许同步远程控制电流和电压。即，用AI来调节电压的同时，不可用前板旋钮调节电流，反之亦然。由于不可用AI调节OVP门限，需要在远程控制模式前以手工设定。用**Preset V/C/OVP**按钮转为预设模式，显示转化后的设定值，传输给AI设定值引脚，作为它的电压。为了设置合适的设定值，用户可借助外电压，或3脚的参考输出电压。

如只要求通过外部手段调节电压，电流设定值(CSEL)可连到参考电压(VREF)。

AI能以普通的0...5V或0...10V范围工作，它们对应0...100%的额定值。产品设置模式（见章节„8. 产品设置“）下可选择所需电压范围。以下适用：

0-5V: 参考电压= 5V, 0...5V设定电压相当于0...100%的额定电压，在实际输出端，则相当于0...100%的实际数值。

0-10V: 参考电压 = 10V, 0...10V设定电压相当于0...100%的额定电压，在实际输出端则对应0...100%的实际数值。

若输入超过极限的设定值，如>5V，当已选择0...5V电压范围，则将有关设定值减至100%而限制。

注意！

请千万别输入高于12V的设定输入值！

请注意：

- 用模拟电压来控制产品需用“REMOTE”(5)引脚转为远程控制模式。
- 连接控制电源的应用设备前，要保证所有连线正确，并检查应用设备不会输入高于指定电压的电压（最大12V）。
- REM-SB(程待机, 13引脚)引脚要优先于**Output On**按钮。意思是，如果该引脚定义输出状态为“off”，就不能用**Output On**按钮打开输出。
- VREF输出引脚给设定值输入脚VSEL和CSEL创建设定值，如仅需电流控制，可将VSEL脚连到VREF脚，然后通过一外电压(0...5V或0...10V)来供电，或通过VREF和地之间的电位器来给CSEL供电。也可参考下一章节。
- 如选择了0...5V电压范围，想输入高达10V的设定值，则高于5V以上的电压会被忽略（被限制），以保证100%的设定值。
- 模拟接口的地与输出负极相连。

10.2 应用举例

D-Sub插座分布总图

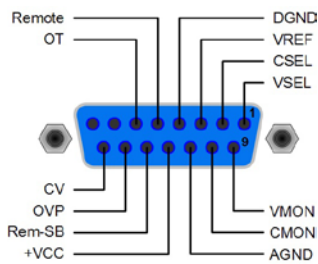

⚠ 注意!

请勿将模拟接口的地接到外控设备（比如：**PLC**）的负输出端，如果连上，就表示控制设备连到了电源输出负极（形成接地回路），负载电流流经控制线，从而损坏设备！为避免此状况出现，可在“弱”地线上接一个保险丝。为避免此情况发生，可在“弱”地线上装一保险丝。

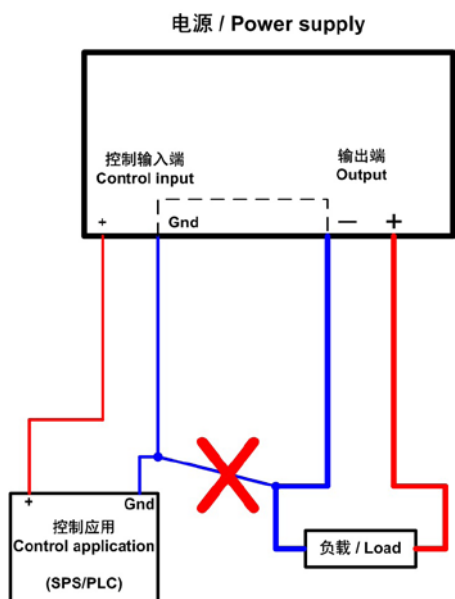
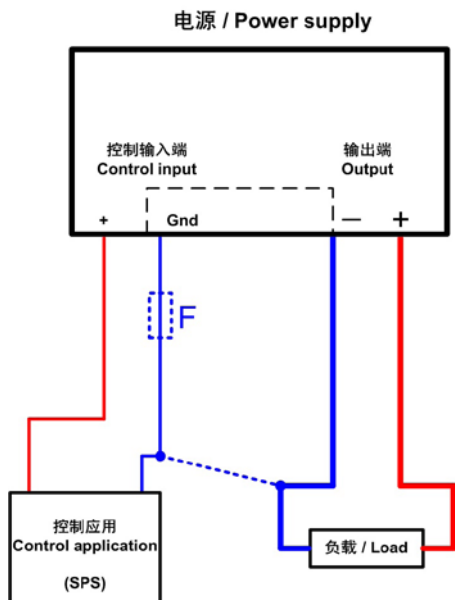

输出关闭

“REM-SB”引脚一直都为工作状态，因此它不依靠远程模式和“REMOTE”引脚，作为其中一控制输入脚，在无外部手段的条件下用来关闭输出，除非LOCAL模式被激活。

因为很多用户没有意识到LOCAL模式，而且不知道该模式的作用。

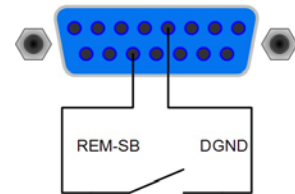

电流和电压的远程控制

VREF和接地脚之间有两电位器，VSEL和CSEL输入端上有一滑动器。利用前板上的旋钮可控制电源，将它当作电流源或电压源用。如果VREF输出脚的电流最大为3mA，则需使用至少为10kOhm的电位器。

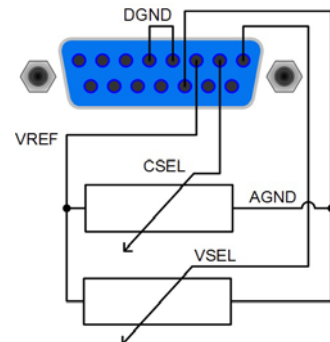

模拟主-从操作

真正的主-从操作是不可能发生的，因为AI没有设定值输出脚。但是可用CMON实际数值输出脚来控制一台或多台同型号电源的CSEL设定值输入脚。任一设定值输入脚都可连到VREF脚。下面的例子显示，从机的电流输入脚通过VREF脚设定为100%，主机通过VMON脚，只能控制从机电压。如果并联，负载电流几乎平均分配给连接着的电源。

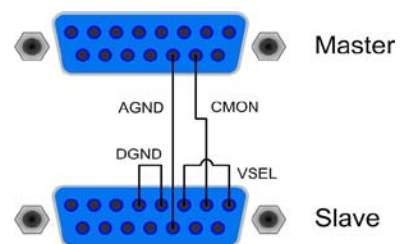

⚠ 提示

即将并联和进行主-从控制的电源，需安装一隔离模拟接口。若已安装，则适用如下：
隔离模拟接口不能连到非隔离模拟接口上！
如果多个隔离模拟接口相互连接，连接上的任何一台产品其支流对模拟接口都不能超过1500V！

10.3 模拟接口各引脚分布

引脚	名称	类型*	描述	状态	电气参数
1	VSEL	AI	设定值: 电压	0...10V对应0..100% of U_{nom}	精确度 < 0,2% 阻值 $R_i > 100K$
2	CSEL	AI	设定值: 电流	0...10V对应0..100% of I_{nom}	
3	VREF	AO	参考电压	10V或5V	$I_{max} = +5mA$ 时, 精确度 < 0.2% 短路保护对AGND
4	DGND	POT	数字控制信号参考电位		For +Vcc, 控制和状态信号
5	REMOTE	DI	在内控和外控间切换	外控 = LOW, $U_{low} < 1V$ 内控 = HIGH, $U_{high} > 4V$ 内控 = OPEN	电压范围 = 0 ...30V $I_{max} = +1mA$ at 5V 发送: 开集电极对DGND
6	OT	DO	过温错误	OT = HIGH, $U_{high} > 4V$ 无OT = LOW, $U_{low} < 1V$	准开集电极上拉至Vcc ** 输出5V时, 电流最大+1mA $U_{CE} = 0.3V$ 时, $I_{max} = -10mA$, $U_{max} = 0...30V$ 短路保护对DGND
7	N.C.				不连
8	N.C.				不连
9	VMON	AO	实际值: 电压	0...10V对应0..100% of U_{nom}	$I_{max} = +2mA$ 时, 精确度Accuracy < 0.2% 短路保护对AGND
10	CMON	AO	实际值: 电流	0...10V对应0..100% of I_{nom}	
11	AGND	POT	模拟信号参考电位		For -SEL, -MON, VREF信号
12	+Vcc	AO	辅助电压输出 (Ref: DGND)	11...13V	$I_{max} = 20mA$ 短路保护对DGND
13	REM-SB	DI	输出关闭	关 = LOW, $U_{low} < 1V$ 开 = HIGH, $U_{high} > 4V$ 开 = OPEN	U range = 0...30V $I_{max} = +1mA$ at 5V 发送: 开集电极对DGND
14	OVP	DO	过压错误	OVP = HIGH, $U_{high} > 4V$ 无OVP = LOW, $U_{low} < 1V$	准开集电极上拉至Vcc ** 输出5V时, 电流最大+1mA $U_{ce} = 0.3V$ 时, $I_{max} = -10mA$ at $U_{max} = 0...30V$ 短路保护对DGND
15	CV	DO	指示电压调整启用	CV = LOW, $U_{low} < 1V$ CC = HIGH, $U_{high} > 4V$ 如果输出关 = HIGH	

* AI = 模拟输入, AO = 模拟输出, DI = 数字输入, DO = 数字输出, POT = 电位

** 内控 Vcc = 13...15V

11. 其它

11.1 其它附件和选项功能

注意：关于附件和选项功能详情，可参考另外的用户指导手册。

可供下列附件：

a) USB-转-模拟接口UTA12

经USB（电脑这边）和产品内部模拟接口可远程控制。

b) 数字接口卡

还配USB, RS232, CAN, GPIB/IEEE (仅SCPI) 或以太网/LAN (仅SCPI) 或Profibus用可插拔式数字接口卡。

可供下列选项功能：

a) High Speed Ramping (仅针对1kW以上型号)

通过减少输出电容容量来增加输出电压的动态。必须指出的是其它相关输出值也增加！

注意：这是个永久性更改，不可更改回来。

11.2 并联

同型号（最理想）产品并联可增大输出电流。并联时，所有正极直流输出端相互连接，所有负极直流输出端相互连接。

并联连接的方式有好几种：

a) 为执行主从操作而将多台产品的模拟接口连接起来。详情请参考„10.2 应用举例“。此处主机将控制所有辅机，或者下一台即将成为下一个主机的辅机。被指定为主机的产品可用接口卡另外被监控或远程控制。这样主机就不形成总输出值。

优点：负载分布均匀，可监控主机，主机上的实际值按机台（同型号）数量相乘可算出，无需外部模拟控制器。

缺点：因为连线是按照这种方式进行的，即第一台产品是下一台的主机，一旦从机因故障而断电，则连接链上其它机台都不再有输出；如果主机断电从而整个系统也无输出。

b) 外部控制器（如：PLC）提供所需模拟设定值，分开控制每台产品。仅将控制器的直流输出端并联在一起。

优点：可更好地监控单个产品。如果一台产品出故障，其它产品仍可无间断工作。

缺点：需用到外部硬件，长信号线易受信号影响以及高频干扰，不确保负载分配均匀，无主从。

11.3 串联

输将输出电压相同或不同，与输出电流相同的电源产品串联可获得更高总电压。

此种连接方式，最小输出电流的产品将决定整个设置的最大电流。



注意！

- 产品之间的模拟接口决不能连接在一起。
- 不可进行主从连接。每台产品需分开控制。
- 如果某一台电源的直流输出极已接地，为保证安全，仅需将最低电位的输出端接地，并且为直流负极（-）。
- 串联后的总直流输出电压允许为600V，且绝不可超过该值！

11.4 固件更新

只有当产品出现错误行为或者应用新功能时才需进行产品固件更新。

要更新一台产品固件，需要用到某一数字接口卡，新的固件文档，称作“更新工具”的Windows软件。

下列这些接口卡才能用于固件更新：

- IF-U1 (USB)
- IF-R1 (RS232)
- IF-E1 (Ethernet/USB)
- IF-PB1 (Profibus/USB)

如果手上没有一张上述接口卡，则不可更新。请立即联系您的产品销售方寻求解决方案。

产品对应的更新工具和固件文档可从产品制造商网站获取，或者发邮件索取。更新工具将会指导用户整个半自动更新过程。

About

Elektro-Automatik GmbH & Co. KG

Helmholtzstrasse 31-33

41747 Viersen

Germany

Phone: +49 2162 / 37850

Fax: +49 2162 / 16230

Web: www.elektroautomatik.de

Mail: ea1974@elektroautomatik.de

© Elektro-Automatik

Reprint, duplication or partly, wrong use of this user instruction manual are prohibited and might be followed by legal consequences.

Danger to life!

Hazardous voltage

The output voltage of some models can rise up to hazardous levels of $>60V_{DC}$!

All live parts have to be covered. All actions at the output terminals have to be done while the unit is switched off from the mains (mains switch OFF) and may only be executed by personnel which is instructed about the hazards of electrical current. Any connection between the load and the unit (at the output terminals) have to be scoop-proof. Applications connected to the power output must be configured and fused in a way that prevents the use of these to cause a damage or worse to the unit by overload or malfunction.

Caution!

The DC output can still have hazardous voltage for a certain time after the output or the device has been switched off!

Keep in mind

- Only operate the device at a mains voltage as stipulated on the type plate
- Never insert mechanical parts, especially from metal, through the air ventilation slots
- Avoid any use of liquids of any kind in the proximity of the device, they might get into it
- Do not connect voltage sources to the device which are able to generate voltages higher than the nominal voltage of the device
- In order to equip interface cards into the slot at the rear, the common ESD provisions have to be followed
- The interface card may only be plugged and unplugged while the unit is completely switched off (mains switch OFF)
- Aging of the device, as well heavy use may result in unpredictable behaviour of control elements like pushbuttons and rotary knobs.
- Do not connect voltage sources with reversed polarity to the DC output! The device will be destroyed.
- Do not connect any voltage source to the DC output, if avoidable, especially not those who can produce voltages higher than specified for the device!

	Page
1. Introduction.....	21
2. Technical specifications.....	21
2.1 Control panel and display	21
2.2 Device specific data.....	22
3. Device description.....	23
3.1 Front view	23
3.2 Other views.....	24
3.3 Scope of delivery	25
4. General.....	25
4.1 Prologue / Warning.....	25
4.2 Cooling	25
4.3 Maintenance / repair.....	25
5. Installation	25
5.1 Visual check.....	25
5.2 Mains connection.....	25
5.3 DC output terminal.....	25
5.4 Terminal „Sense“ (Remote sense)	25
5.5 Interface card slot	25
6. Handling	26
6.1 The display	26
6.2 Pushbuttons on the control panel	26
6.2.1 Pushbutton Preset V/C/OVP.....	26
6.2.2 Pushbutton Memory M1...M5.....	26
6.2.3 Pushbutton Fine/Setup	26
6.2.4 Pushbutton Lock/Local	27
6.2.5 Pushbutton Output on.....	27
6.3 Further control elements.....	27
6.3.1 Pushbutton Standby	27
6.4 Adjusting set values.....	27
7. Device characteristics	28
7.1 Switching on by power switch.....	28
7.2 Switching off by power switch.....	28
7.3 Activating standby mode	28
7.4 Switching to remote control	28
7.5 Overvoltage alarms	28
7.6 Overtemperature alarms.....	28
7.7 Current or voltage regulation	28
7.8 Remote sense	28
7.9 Mains undervoltage or overvoltage occurs.....	29
7.10 Connecting different types of loads	29
8. Device setup.....	29
9. Digital interface cards.....	30
10. Analogue interface	30
10.1 General.....	30
10.2 Example applications.....	31
10.3 Pin specification.....	32
11. Miscellaneous.....	33
11.1 Accessories and options.....	33
11.2 Parallel connection	33
11.3 Series connection	33
11.4 Firmware update.....	33

1. Introduction

The laboratory power supplies of the series PS 8000T are very compact and rugged devices and incorporate interesting features within small dimensions.

Apart from standard functions of power supplies the user can define and recall 5 different presets of set values or make use of the integrated analogue interface, that can handle the common voltage ranges of 0...5V or 0...10V.

This offers a way of easily monitoring the device as well as total remote control. The optionally available, digital interface cards for provide an even wider spectrum of control and monitoring functions by means of a PC.

The integration into existent systems is done very comfortably by using an interface card, while there is no need to configure the card at all or with only a few settings.

Via the analogue interface, the power supply can also be operated in connection to other power supply units, controlling these via the interface. Or they can be controlled and monitored by an external control system, like a PLC.

The device is microprocessor-controlled and thus delivers fast and accurate measurement and indication of actual values.

The tower design allows space-saving conception of even complex and highly productive applications, like for example industrial test equipment with variable power for various demonstration and testing purposes in research & development or educational areas.

The main functions at a glance:

- Set voltage and current, each with 0...100%
- Adjustable overvoltage threshold 0...110% U_{Nom}
- Pluggable interface cards (CAN, USB, RS232, IEEE/GPIB, Ethernet/LAN, Profibus)
- Analogue interface for external control and monitoring with 0...5V or 0...10V (selectable) for 0...100%
- Power ratings of 320W, 640W, 1000W and 1500W
- Temperature controlled fan
- Status indication (OT, OVP, CC, CV) with LEDs
- Standby mode
- 5 selectable memory sets
- Vector™ compatible CAN system
- Free Windows software
- LabView™ VIs

2. Technical specifications

2.1 Control panel and display

Type

Display: LED 7 segment display with four digits plus comma, LEDs

Knobs: 2 rotary knobs, 6 pushbuttons

Display formats

The nominal values define the maximum adjustable range.

Actual values and set values for voltage and current are displayed simultaneously, the set value of the overvoltage threshold is displayed separately.

Display of voltage values

Digits: 4
 Formats: 0.00V...99.99V
 0.0V...999.9V

Display of current values

Digits: 4
 Formats: 0.000A...9.999A
 0.00A...99.99A

2.2 Device specific data

	PS 8016-20 T	PS 8032-10 T	PS 8065-05 T	PS 8032-20 T	PS 8065-10 T	PS 8160-04 T	PS 8080-40 T	PS 8360-10 T	PS 8080-60 T	PS 8360-15 T
Mains input										
Input voltage	90...264V AC	90...264V AC	90...264V AC	90...264V AC	90...264V AC	90...264V AC	90...264V AC	90...264V AC	90...264V AC	90...264V AC
Frequency	45...65Hz	45...65Hz	45...65Hz	45...65Hz	45...65Hz	45...65Hz	45...65Hz	45...65Hz	45...65Hz	45...65Hz
Fuse	T 4A	T 4A	T 4A	T 8A	T 8A	T 8A	T 16A	T 16A	T 16A	T 16A
Power factor	> 0.99	> 0.99	> 0.99	> 0.99	> 0.99	> 0.99	> 0.99	> 0.99	> 0.99	> 0.99
Inrush current	< 25A	< 25A	< 25A	< 25A	< 25A	< 25A	< 25A	< 25A	< 25A	< 25A
Power consumption at output off	12W	12W	12W	12W	12W	12W	31W	31W	31W	31W
Power consumption at standby	7W	7W	7W	7W	7W	7W	11W	11W	11W	11W
Output - Voltage										
Nominal voltage U_{nom}	16V	32V	65V	32V	65V	160V	80V	360V	80V	360V
Adjustable range	0V... U_{nom}	0V... U_{nom}	0V... U_{nom}	0V... U_{nom}	0V... U_{nom}	0V... U_{nom}	0V... U_{nom}	0V... U_{nom}	0V... U_{nom}	0V... U_{nom}
Stability at mains fluctuation $\pm 10\% \Delta U_{IN}$	< 0.02%	< 0.02%	< 0.02%	< 0.02%	< 0.02%	< 0.02%	< 0.02%	< 0.02%	< 0.02%	< 0.02%
Stability at 10...90% load	< 0.05%	< 0.05%	< 0.05%	< 0.05%	< 0.05%	< 0.05%	< 0.05%	< 0.05%	< 0.05%	< 0.05%
Ripple HF BWL 20MHz	< 40mV P-P	< 100mV P-P	< 150mV P-P	< 100mV P-P	< 150mV P-P	< 120mV P-P	< 10mV P-P	< 30mV P-P	< 10mV P-P	< 50mV P-P
Ripple LF BWL 20MHz	< 4mV RMS	< 10mV RMS	< 20mV RMS	< 8mV RMS	< 10mV RMS	< 20mV RMS	< 4mV RMS	< 11mV RMS	< 4mV RMS	< 8mV RMS
Accuracy*	$\leq 0.2\%$	$\leq 0.2\%$	$\leq 0.2\%$	$\leq 0.2\%$	$\leq 0.2\%$	$\leq 0.2\%$	$\leq 0.2\%$	$\leq 0.2\%$	$\leq 0.2\%$	$\leq 0.2\%$
Resolution of display	10mV	10mV	10mV	10mV	10mV	100mV	10mV	100mV	10mV	100mV
Remote sense compensation	max. 2V	max. 2V	max. 2V	max. 2V	max. 2V	max. 2V	max. 2.5V	max. 8V	max. 2.5V	max. 8V
Overvoltage protection threshold (adjustable)	0...17.6V	0...35.2V	0...71.5V	0...35.2V	0...35.2V	0...176V	0...88V	0...396V	0...88V	0...396V
Output - Current										
Nominal current I_{nom}	0...20A	0...10A	0...5A	0...20A	0...10A	0...4A	0...40A	0...10A	0...60A	0...15A
Adjustable range	0A... I_{nom}	0A... I_{nom}	0A... I_{nom}	0A... I_{nom}	0A... I_{nom}	0A... I_{nom}	0A... I_{nom}	0A... I_{nom}	0A... I_{nom}	0A... I_{nom}
Stability at mains fluctuation $\pm 10\% \Delta U_{IN}$	< 0.05%	< 0.05%	< 0.05%	< 0.05%	< 0.05%	< 0.05%	< 0.05%	< 0.05%	< 0.05%	< 0.05%
Stability at 0...100% ΔU_{OUT}	< 0.15%	< 0.15%	< 0.15%	< 0.15%	< 0.15%	< 0.15%	< 0.15%	< 0.15%	< 0.15%	< 0.15%
Ripple HF BWL 20MHz	< 60mA P-P	< 35mA P-P	< 12mA P-P	< 65mA P-P	< 25mA P-P	< 3mA P-P	< 19mA P-P	< 1mA P-P	< 19mA P-P	< 1mA P-P
Ripple LF BWL 20MHz	< 10mA RMS	< 7mA RMS	< 3mA RMS	< 10mA RMS	< 3mA RMS	< 1mA RMS	< 7mA RMS	< 0.45mA RMS	< 7mA RMS	< 0.45mA RMS
Accuracy*	$\leq 0.2\%$	$\leq 0.2\%$	$\leq 0.2\%$	$\leq 0.2\%$	$\leq 0.2\%$	$\leq 0.2\%$	$\leq 0.2\%$	$\leq 0.2\%$	$\leq 0.2\%$	$\leq 0.2\%$
Resolution of display	10mA	10mA	1mA	10mA	10mA	1mA	10mA	10mA	10mA	10mA
Ramp-up time $t_{0...90\% \text{ load}}$	< 2ms	< 2ms	< 2ms	< 2ms	< 2ms	< 2ms	< 2ms	< 2ms	< 2ms	< 2ms
Output - Power										
Nominal power P_{nom}	320W	320W	325W	640W	640W	640W	1000W	1000W	1500W	1500W
Nominal power $< 150V U_{in}$	320W	320W	325W	640W	640W	640W	1000W	1000W	1000W	1000W
Miscellaneous										
Operation temperature	0...40°C	0...40°C	0...40°C	0...40°C	0...40°C	0...40°C	0...40°C	0...40°C	0...40°C	0...40°C
Storage temperature	-20...70°C	-20...70°C	-20...70°C	-20...70°C	-20...70°C	-20...70°C	-20...70°C	-20...70°C	-20...70°C	-20...70°C
Humidity rel.	< 80%	< 80%	< 80%	< 80%	< 80%	< 80%	< 80%	< 80%	< 80%	< 80%
Dimensions of enclosure (WxHxD)	90x240x280mm	90x240x280mm	90x240x280mm	90x240x280mm	90x240x280mm	90x240x280mm	90x240x395mm	90x240x395mm	90x240x395mm	90x240x395mm
Weight	3.8kg	3.8kg	3.8kg	3.8kg	3.8kg	3.8kg	6.5kg	6.5kg	6.5kg	6.5kg
Safety	EN 60950									
EMC standards	EN 61326, EN 55022 Class B									
Overvoltage class	Class II									
Protection class	Class I									
Article number	09200120	09200121	09200122	09200123	09200124	09200125	09200126	09200128	09200127	09200129

* Related to the nominal value



3. Device description

3.1 Front view

Description of the knobs, buttons and terminals:

1) Power output, safety sockets, poled

The sockets can be used to plug 4mm Bueschel plugs or to clamp spade lugs.

 Attention!
<p><i>With the 1000W and 1500W models, the 4mm front sockets of the DC output connectors are only approved for max. 32A!</i></p>

2) Remote sense input, poled

The remote sense leads are connected here with correct polarity. For details about the remote sense feature refer to section 7.8.

3) Analogue interface, 15pole, D-Sub, female

The socket can be used to remotely control and monitor the device by means of analogue resp. digital signals. For more information refer to section „10. Analogue interface“.

4) Pushbutton „Standby“

Is used to switch the device into standby and back to normal operation.

5) Rotary knob, right, no stop

Is used to adjust the set value of the output current.
 Approximately 5 complete turns correspond to 0...100%.
 In the setup, it is used to adjust settings.
 Also see sections „6.4 Adjusting set values“ and „8. Device setup“.

6) Rotary knob, left, no stop

Is used to adjust the set value for the output voltage and in preset mode, also to adjust the OVP threshold.
 Approximately 5 complete turns correspond to 0...100%.
 In the setup, it is used to select parameters.
 Also see sections „6.4 Adjusting set values“ and „8. Device setup“.

7) Control panel and display unit

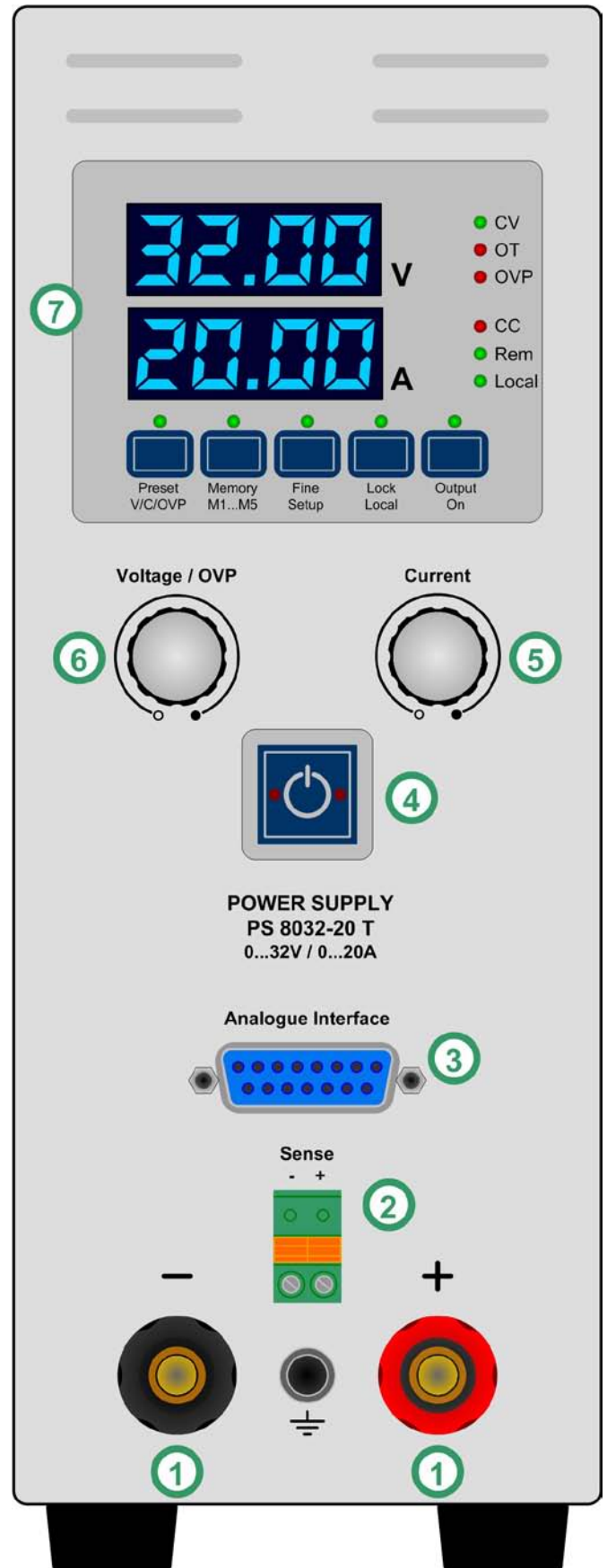

Figure 1

3.2 Other views

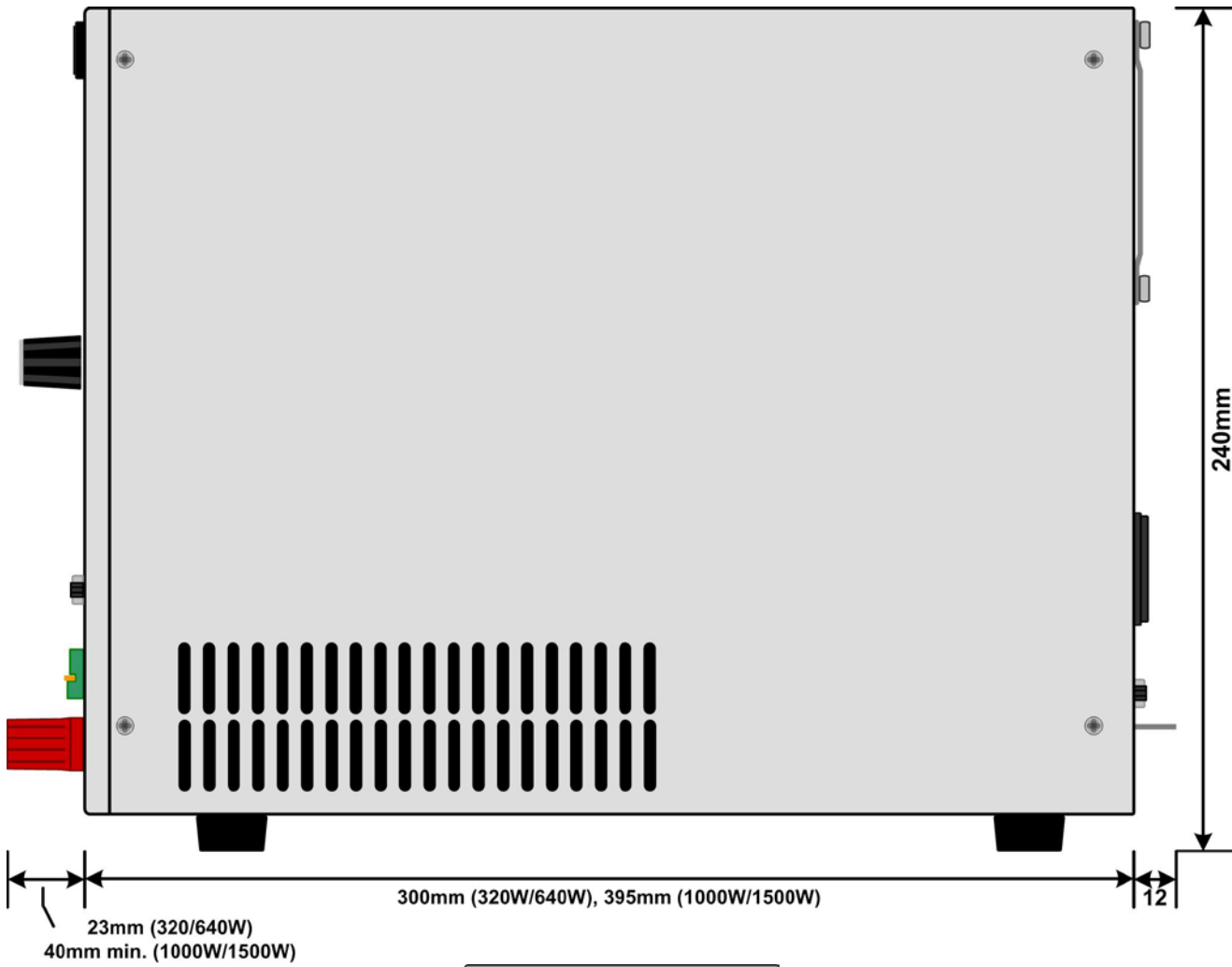

Figure 2

1000W / 1500W:
max. 32A →
max. 63A ↑

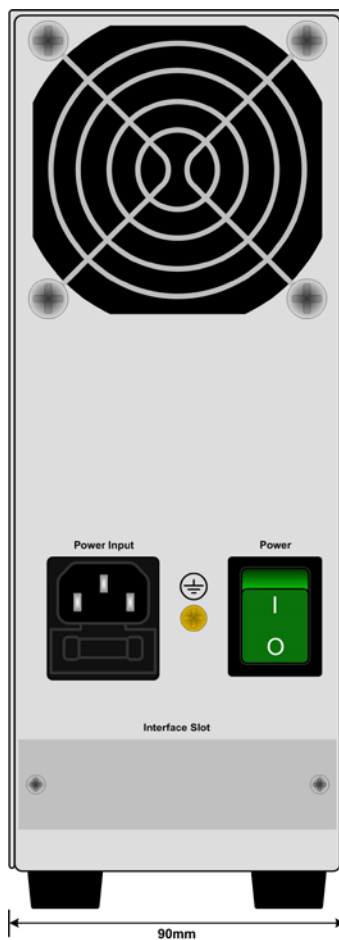

Figure 3

3.3 Scope of delivery

- 1 x Power supply unit
- 1 x Printed user manual
- 1 x Mains cord

4. General

4.1 Prologue / Warning

This user instruction manual and the device are intended to be used by users who know about the principle of a power supply. The handling of the device should not be left to persons who are unaware of the basic terms of electrotechnology, because these are not described in this manual. Inappropriate handling and non-observance to the safety instructions may lead to a damage of the device or loss of warranty!

4.2 Cooling

The air inlets on the side and the air outlets at the rear have to be kept clean to ensure proper cooling. Take care of at least 10cm distance at the rear to any surrounding objects in order to guarantee unimpeded air flow.

4.3 Maintenance / repair

When opening the unit or removing parts from the inside with tools there is risk of electric shock by dangerous voltages. Open the unit only at your own risk and disconnect it from the mains before. Any servicing or repair may only be carried out by trained personnel, which is instructed about the hazards of electrical current.

5. Installation

5.1 Visual check

After receipt, the unit has to be checked for signs of physical damage. If any damage is found, the unit may not be operated. Also contact your dealer immediately.

5.2 Mains connection

The unit is grounded via the mains cord. Thus the unit may only be operated at a mains socket with grounding contact. This must not be interrupted by an extension cable without ground conductor!

The unit is fused with a 5 x 20mm safety fuse (for value see technical specs table), which is accessible inside the mains socket.

5.3 DC output terminal

The power output is located on the front of the device.

The output is **not** fused! In order to avoid damage to the load application, always take care for the nominal values of the load.

The cross section of the leads depends on several conditions, like the output current, the lead length and the ambient temperature.

Up to 1.5m lead length we recommend to use:

up to 5A :	0.5mm ² ,	up to 10A :	0.75mm ²
up to 15A :	1.5mm ²	up to 20A :	2.5mm ²
up to 40A :	6mm ² ,	up to 60A :	16mm ²

per cable (flexible wire).

The outputs “+” and “-” are not grounded, so that **one** of them may be grounded if necessary.

Attention!

When grounding one of the output poles always check if one of the poles of the load (eg. electronic load) is also grounded. This could result in a short-circuit!

Attention!

Notice the potential shift of the output poles when using series connection! Grounding is hereby only recommended at the pole with the lowest potential against ground.

Attention!

With the 1000W and 1500W models, the 4mm front sockets of the DC output connectors are only approved for max. 32A!

5.4 Terminal „Sense“ (Remote sense)

In order to compensate the voltage drop along the load leads (max. 1V per lead), the power supply can „sense“ the voltage at the load instead at the output. It will regulate the output voltage so that the desired voltage is provided to the load.

The remote sense feature is wired with correct polarity to the terminal **Sense**.

Attention!

(+) Sense must only be connected to (+) at the load application and (-) Sense must only be connected to (-)! Else both systems can take damage.

For additional information also see section 7.8.

5.5 Interface card slot

The unit can be equipped with an optional interface card. The slot to insert the card is located at the rear side. Further information about the interface cards can be found in section „9. Digital interface cards“.

6. Handling

6.1 The display

Figure 4 shows an overview of the LED displays, the LEDs and the control panel. During normal operation, the displays show the actual values of voltage (upper) and current (lower). In preset mode, the displays show the set values of voltage or OVP (upper) and current (lower), while in setup mode the upper display shows the selected parameter and the lower one the related setting.

The status LEDs (to the right) indicate following:

CV - Voltage regulation active (only if output is „on“)

OT - Overtemperature error

OVP - Overvoltage error

CC - Current regulation active (only if output is „on“)

Rem - Remote control active (digital or analogue)

Local - LOCAL mode active

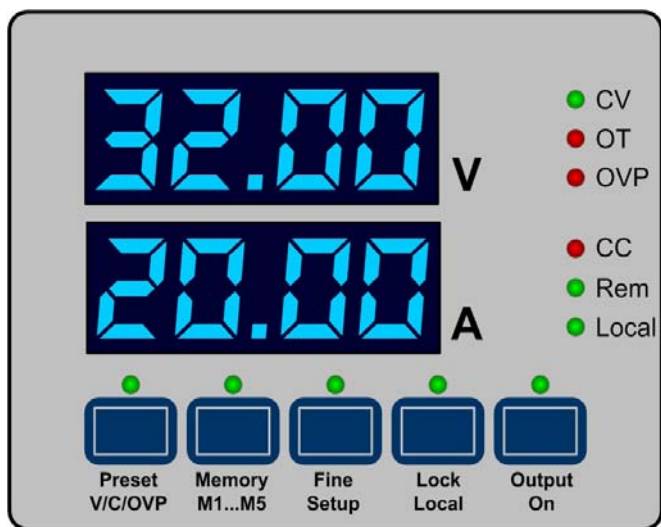
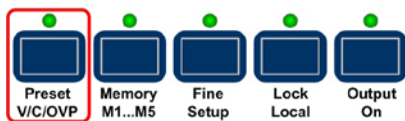

Figure 4

6.2 Pushbuttons on the control panel

6.2.1 Pushbutton Preset V/C/OVP



This button is used to switch to set values display, i.e. preset mode. One push switches to the set values of U and I, a second push to the set value or threshold of the OVP. In order to distinguish, in the lower display the text „OVP“ is displayed. The LED above the button indicates the preset mode. Set values can be adjusted with both rotary knobs in ranges of 0...100% for U_{Max} or I_{Max} , as well as 0...110% U_{Max} for OVP. The values are instantly submitted to the output.

A third push exits the preset mode. Alternatively, it is canceled automatically if no set value is changed for more than 5 seconds.

During remote control by analogue or digital interface, the button is used to display the set values that are currently set by the controlling interface. When controlling with the analogue interface, the OVP threshold can not be adjusted from external, so the display will show the most recent value.

The pushbutton may be locked by the **LOCK** state. See 6.2.4.

6.2.2 Pushbutton Memory M1...M5

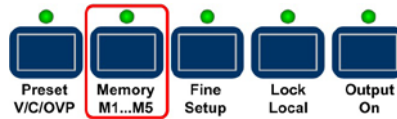

This pushbutton has two functions: it either selects one of the five memory sets with U, I, OVP set values for submission or it saves the memory sets. Note: the button only works if the output is **switched off**. The memory mode is indicated by the LED above the button.

Available actions:

a) Select and submit

While the output is off, push button once and the display will show memory set 1 (M1), indicated by shortly displaying the set number like this:



After this, the set values of U (upper) and I (lower) are shown. Switching to OVP set value is done with the button **Preset V/C/OVP**, like in preset mode.

Further pushes with button **Memory M1...M5** will scroll through all five memory sets and then exit.

b) Submit only

While the output is off and a memory set selected (1-5), button **Output On** is pushed --> the set values of the selected memory set are submitted to the DC output and the output is switched on.

! Note

If changed, the selected memory set will not be stored by this action.

c) Store only

While the output is off, select one of the five memory sets and adjust the values as desired, then press the button **Memory M1...M5** for more than three seconds --> all memory sets are stored, but none is submitted. The output remains off and the memory mode will exit after the sets are stored.

The memory sets can also be defined by remote control and corresponding commands using the various digital interfaces (except via SCPI command language as used by the GPIB and Ethernet interfaces). They are stored instantly.

The pushbutton may be locked by the **LOCK** state. See 6.2.4.

6.2.3 Pushbutton Fine/Setup

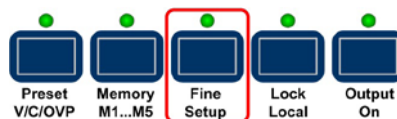

This pushbutton has two functions: it either switches between **fine** or **coarse** adjustment mode of the set values or it activates the setup mode.

Available actions:

a) Short push --> fine adjustment mode on/off. The activated „Fine“ mode is indicated by the LED above the button. In „Fine“ mode, all set values can now be adjusted with the smallest possible step width (last digit). Deactivating fine mode switches to coarse mode. Also see section „6.4 Adjusting set values“.

b) While the output is off, press button >3s --> device changes to setup mode. For details see section „8. Device setup“. After all settings are done, press button again for >3s --> device setup will exit, the settings are saved and the LED above the button will flash three times.

The pushbutton may be locked by the **LOCK** state. See 6.2.4.

6.2.4 Pushbutton Lock/Local

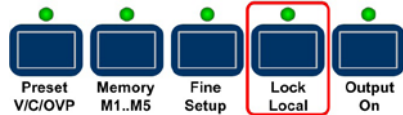

This pushbutton has two functions: either activate/deactivate the control panel LOCK or activate/deactivate the LOCAL mode.

Note
Activation of LOCAL mode results in immediate return from remote control (analogue or digital) and locks the device against further attempts to control it remotely, until LOCAL is deactivated again.

Available actions:

a) Short push --> LOCK on/off. It means, it locks all pushbuttons, except button **Lock**, and the rotary knobs. The LOCK mode is indicated by the LED above the button. Locking the control panel prevents unintended use of the pushbuttons and the rotary knobs.

b) Press >3s (as long as LOCK's not active) --> LOCAL on/off. With „on“ the device is switched to manual operation. It means, it can not be remotely controlled by analogue or digital interface, as long as LOCAL is active. Activating LOCAL also immediately exits any remote control condition. The activated LOCAL mode is indicated by the LED **Local**.

Note
LOCK condition is saved and restored after switching the device on (only since device firmware 6.03)

6.2.5 Pushbutton Output on

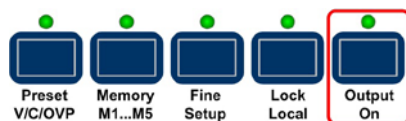

This pushbutton is used to manually switch the power output on or off, as long as the device is not in remote control mode. The state of the output is indicated by the LED above the button. During output on, the regulation mode (CC or CV) is indicated by the corresponding LED. If the output is off, both LEDs are also off.

The pushbutton may be locked by the **LOCK** state. See 6.2.4. Switching the output on may be inhibited by pin 13 (REM-SB) of the analogue interface. For details see section „10. Analogue interface“.

The button also acknowledges the OVP alarm. If an overvoltage occurs and the cause of the OV is removed or gone, the LED „OVP“ will remain lit until the alarm is acknowledged by the button.

6.3 Further control elements

6.3.1 Pushbutton Standby



Activates or deactivates the standby mode. When pushed, any current mode is canceled and the total display is shut off.

The device „remembers“ the last output condition and set values and will restore them after return from standby. The same applies for a return when it has been switched off by the mains switch or a mains blackout happened, while the device was in standby.

Attention!
In case the device setup is active while switching to standby, altered settings are not saved!

6.4 Adjusting set values

1. Manual operation

During manual operation, both rotary knobs are used to continuously adjust the set values of voltage and current from 0% to 100% nominal value in predefined steps (see below). In preset mode, the OVP threshold can also be adjusted from 0% to 110% nominal voltage. In order to adjust the OVP, button **Preset V/C/OVP** is pushed twice before.

The OVP threshold can be set to lower than the voltage set value! This either results in an immediate OVP error and switches off the output, as soon as the actual voltage exceeds the OVP threshold, or prevents the output to be switched on.

Setting values manually can be done in fine or coarse steps, whereas coarse is default. Fine is required to be activated by the button **Fine** and has a step width of 1.

For **coarse** adjustment, following step widths apply in dependency of the nominal values (see: technical specs):

Voltage / OVP		Current	
Nom. value	Step width	Nom. value	Step width
16V	0.1V	4A	0.05A
32V	0.2V	5A	0.05A
65V	0.5V	10A	0.1A
80V	0.5V	15A	0.1A
160V	1V	20A	0.2A
360V	2V	40A	0.5A
		60A	0.5A

Note
With some device models, the adjustable step of a set value can be smaller than what the device can really transmit to the output and thus the output voltage might react only every second or third step.

2. Remote control by analogue interface

See section „10. Analogue interface“.

3. Remote control by digital interface

See section „9. Digital interface cards“.

7. Device characteristics

7.1 Switching on by power switch

The power switch is located at the rear. After switching the device on it is immediately ready to work. There is an option that determines the state of the power output and set values when the device is switched on. By default, this option is activated (on), meaning that the device will save the last output condition, including the set values, when it is switched off by the power switch and restore the condition after the next start.

If the option is deactivated (off), the set values of U and I are set to 0 and the output is switched on after every start.

7.2 Switching off by power switch

Switching the device by power switch is handled as mains black-out. The device will save the last set values and output condition. After a short time, power output and fan will be switched off and after a few seconds more, the device will be completely off.

7.3 Activating standby mode

Generally, if standby is activated by pushing the standby button, the device acts like when switched off by power switch. The condition of the output is restored or set to a default, depending on the option „P on“ in the device setup.

7.4 Switching to remote control

a) *Analogue interface:* Pin „Remote“ switches the device to analogue remote control via pins VSEL (1), CSEL (2) and REM-SB (13), if not inhibited by LOCAL mode or remote mode via a digital interface already being active. The output condition and the set values are immediately set. After returning from remote control into manual control, the output will be switched off automatically.

b) *Digital interface:* Switching to digital remote control by a corresponding command (here: object), if not inhibited by LOCAL condition or analogue remote control being active, keeps output state and set values until altered. Returning from remote control automatically switches the output off.

7.5 Overvoltage alarms

An overvoltage alarm can occur due to an internal defect (output voltage rises uncontrolled) or by a too high voltage from external. The overvoltage protection (OVP) will switch off the output and indicate the error by the LED „OVP“ and at the pin „OVP“ on the AI.

If the cause of the overvoltage is removed and the output shall be switched on again, the alarm has to be acknowledged first. In manual operation, it is done by pushing button **Output On**, in analogue remote control with pin „REM-SB“ and in digital remote control by the corresponding command. The LED „OVP“ and pin will then no longer signalise an alarm. If the alarm is still present, the output is not switched on.

OVP alarms are recorded into the internal alarm buffer. This buffer can be read out via digital interfaces, except the ones that use SCPI command language.

7.6 Overtemperature alarms

As soon as an overtemperature (OT) alarm occurs due to internal overheating, the output is switched off and the LED „OT“ is lit. Simultaneously, the LED above the pushbutton **Output On** will flash, indicating that the output will automatically switch on again as soon as the device has cooled down. In case this is not wanted, the output can be manually switched off. Then the LED stops flashing and the output won't switch on automatically.

OT alarms have to be acknowledged. If the output is off after the device has cooled down, this is done by switching the output on using button **Output on** or pin „REM-SB“ or the corresponding command. If the output is on, acknowledgment is done by pushing the button **Output on** once or giving pin „REM-SB“ a high-to-low toggle or using the corresponding command to switch the output off.

OT alarms are recorded into the internal alarm buffer. This buffer can be read out via digital interfaces, except the ones that use SCPI command language.

7.7 Current or voltage regulation

The output voltage and the resistance of the load determine the output current. As long as the output current is lower than the adjusted current set value, the device will operate in constant voltage mode (CV). This is indicated by the LED „CV“.

When the output current is limited by the current set value or the device's nominal current, it will change to constant current mode (CC). This is indicated by the LED „CC“.

7.8 Remote sense

Remote sense operation is used to compensate voltage drops along the leads between the power supply and the load. Because this is limited to a certain level, it is recommended to match the cross section of the leads to the output current and thus minimise the voltage drop. On the frontpanel of the device there is a terminal **Sense** where the sense leads are connected with correct polarity.

The power supply will detect the external sense automatically and compensate the output voltage by the actual voltage at the load instead at the output. The output voltage will be raised by the value of the voltage drop between power supply and load.

Maximum compensation: see technical specifications table

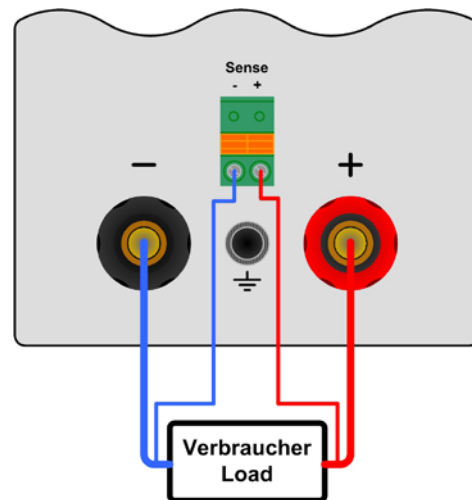

Following setting only for **RS232 interface IF-R1**:

Parameter: *bAud* Default: *576*

Settings: *96, 192, 384, 576*

Meaning: Selects the serial transmission baudrate in hectobaud. 96 means 9600 baud and 576 means 57600 baud etc. Further parameters for the RS232 are not configurable, but used as this:

Parity = odd

Stop bits = 1

Data bits = 8

and have to be set to the same configuration at the PC.

Following settings only with **Profibus interface IF-PB1**:

Parameter: *PbAd* Default: *1*

Settings: *1...125*

Meaning: Defines the Profibus address of the device. This address is used apart from the device node to implement and access the unit on a field bus system.

9. Digital interface cards

The device supports following pluggable interface cards:

IF-U1 (USB)

IF-R1 (RS232)

IF-C1 (CAN)

IF-G1 (GPIB/IEEE)

IF-E1/IF-E1B (Ethernet/LAN + USB)

IF-PB1 (Profibus)

The digital interface cards IF-R1 (RS232), IF-C1 (CAN) and IF-U1 (USB) use a uniform communication protocol. Up to 30 units can be controlled from a PC at once with these cards.

The GPIB interface IF-G1 (IEEE 488) offers a SCPI command structure for up to 15 units per bus. The analogue card IF-A1 is a galvanically isolated, analogue interface with configurable in- and outputs.

The Ethernet/LAN interfaces IF-E1 and IF-E1B also provide SCPI command set. They feature an additional USB port which makes the device accessible like with the IF-U1 card.

A further interface card for Profibus connection, the IF-PB1, is available

The cards require only a little or no setup after insertion. The card specific settings are kept, even if the card is replaced by one of different type. Thereby it is not necessary to configure the card settings everytime a card is inserted.

Details about the technical specs of the interface cards and the handling, as well as instructions to implement the device into a bus system or to control the device by means of a PC (LabView etc.) can be found in the user manual for the IF cards.

Attention!

Insertion or removal only if the device is completely switched off (power switch)!

About configuration of the plugged cards see section „8. Device setup“.

The digital interfaces allow to set voltage and current, as well as the OVP threshold by means of a PC. When changing to remote control mode, the device keeps the last set values until they're altered. Hence it would be possible to control only voltage by sending arbitrary set values and the current set value would remain unaltered.

Set values given by the digital interface (except GPIB) are always percentage and correspond at 100% (hex: 0x6400) resp. at 110% (hex: 0x6E00) for the OVP threshold, to the nominal values of the device.

Furthermore, the digital interfaces allow to query and set a lot of other features and values.

10. Analogue interface

10.1 General

The 15 pole analogue interface is located on the front and offers, amongst others, following possibilities:

- Remote control of current and voltage 0...100%
- Remote monitoring of status (OT, OVP, CC, CV)
- Remote monitoring of actual values 0...100%
- Remotely switching the output on/off

The analogue interface (AI) allows to remotely control current and voltage, always in combination. It means, that it's not possible to adjust voltage by the AI and the current with the rotary knob on the front at the same time, or vice versa. Because the OVP threshold can not be adjusted via the AI, it's required to set it manually on the device before using the remote control. Switching to preset mode with the pushbutton **Preset V/C/OVP** shows the translated set values, that are put into the set value pins of the AI as voltages. In order to put in the appropriate set values, the user can either use an external voltage or the reference output voltage on pin 3.

In case it is only required to adjust voltage by external means, the current set value (CSEL) can be bridged to the reference voltage (VREF).

The AI can be operated with the common 0...5V or 0...10V ranges, each corresponding to 0...100% nominal values. The desired voltage range is selected in the device setup (see section „8. Device setup“). Following applies:

0-5V: Reference voltage = 5V, 0...5V set value voltage correspond to 0...100% nominal value, 0...100% actual value correspond to 0...5V at the actual value outputs.

0-10V: Reference voltage = 10V, 0...10V set value voltage correspond to 0...100% nominal value, 0...100% actual value correspond to 0...10V at the actual value outputs.

Putting in set values that exceed the limit, for example >5V while the 0...5V range is selected, is intercepted by clipping the concerning set value to 100% .

Attention!

Never input voltages higher than 12V to the set value inputs!

Please note:

- Controlling the device with analogue voltages requires to switch it to remote control with pin „REMOTE“ (5).
- Before connecting the application that is used to control the power supply, make sure to wire all leads correctly and check if the application is unable to input voltages higher than specified (max. 12V).
- The input REM-SB (remote standby, pin 13) overrides the pushbutton **Output On**. It means, the output can not be switched on by the button if the pin defines the output state as „off“.
- The output VREF can be used to build set values for the set value inputs VSEL and CSEL. For example, if only current control is required, pin VSEL can be bridged to VREF and CSEL is either fed by an external voltage (0...5V or 0...10V) or via a potentiometer between VREF and ground. Also see next section.
- Putting in set values up to 10V while 0...5V range is selected will ignore any voltage above 5V (clipping) and keep the set value at 100%.
- The grounds of the analogue interface are related to minus output.**

10.2 Example applications

Overview D-Sub socket

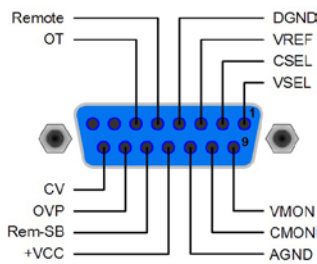

⚠ Attention!

Attention! Never connect grounds of the analogue interface to minus (negative) output of an external control application (PLC, for example), if that control application is otherwise connected to the negative power supply output (ground loop). Load current may flow over the control leads and damage the device! In order to avoid this a fuse can be integrated in the „weak“ ground line.

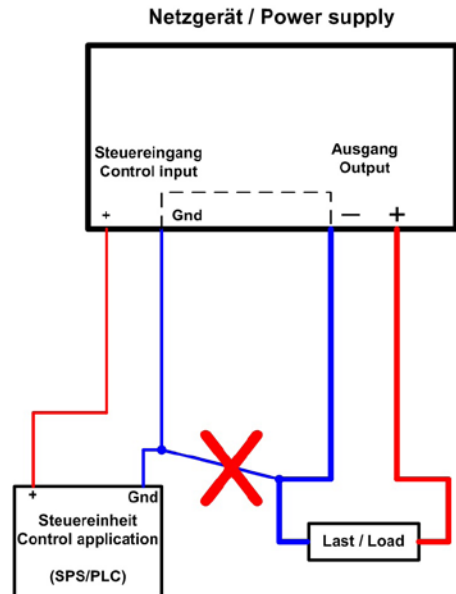

Output off

Pin „REM-SB“ is always operative, so it does not depend on the remote mode and pin „REMOTE“, even as one of the control inputs and can thus be used to switch the output off without extra means, except LOCAL condition is activated.

Because many users are not aware of LOCAL and what it does.

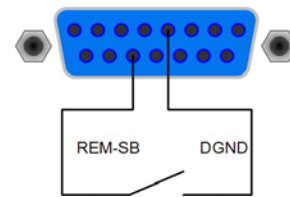

Remote control of current and voltage

Two potentiometers between VREF and ground, sliders at the inputs VSEL and CSEL. The power supply can be controlled as with the rotary knobs on the front and can either operate as current or voltage source. In compliance with the max. 3mA for the VREF output, potentiometers with at least 10kOhm have to be used.

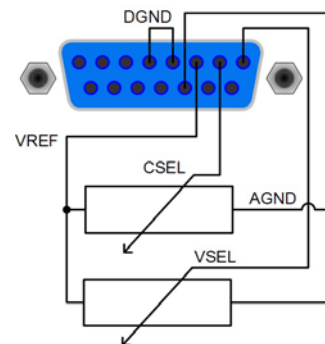
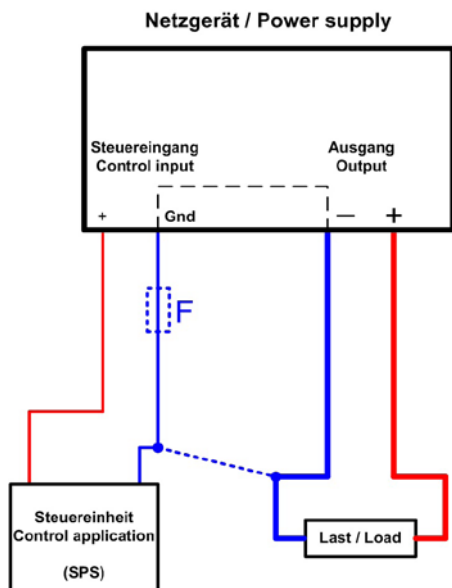

Emulated Master-Slave operation

True Master-Slave operation is not possible, because the AI does not provide set values outputs. But the actual value output CMON can be used to control the set values input CSEL of one or multiple different power supplies of the same type. Any open set value input can be tied to VREF. In the example below, the current input of the slave is set to 100% by VREF and the master only controls the slave voltage with VMON. In a parallel connection, the load current will distribute amongst the power supplies almost uniformly.

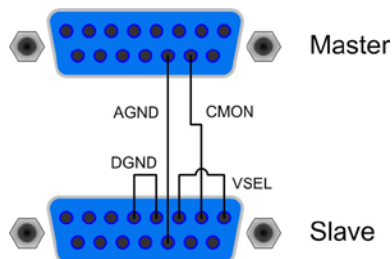

Note

Power supplies which are going to be used in parallel connection and master-slave control might have an isolated analogue interface equipped. If so, following applies:

An isolated analogue interface must not be connected to a non-isolated analogue interface!

If multiple isolated analogue interfaces are connected to each other, none of the devices must have a potential of >1500V DC against the analogue interfaces!

10.3 Pin specification

Pin	Name	Type*	Description	Level	Electrical specification
1	VSEL	AI	Set value: voltage	0...10V or 0...5V correspond to 0..100% of U_{nom}	Accuracy < 0,2% Impedance $R_i > 100K$
2	CSEL	AI	Set value: current	0...10V or 0...5V correspond to 0..100% of I_{nom}	
3	VREF	AO	Reference voltage	10V or 5V	Accuracy < 0.2% at $I_{max} = +5mA$ Short-circuit-proof against AGND
4	DGND	POT	Reference potential for digital control signals		For +Vcc, control and status signals
5	REMOTE	DI	Toggle between internal or external control	External = LOW, $U_{low} < 1V$ Internal = HIGH, $U_{high} > 4V$ Internal = open	U range = 0 ...30V $I_{max} = +1mA$ at 5V Sender: Open collector against DGND
6	OT	DO	Overtemperature error	OT = HIGH, $U_{high} > 4V$ no OT = LOW, $U_{low} < 1V$	Quasi open collector with pull-up to Vcc ** At 5V at the output there will be max.+1mA $I_{max} = -10mA$ at $U_{CE} = 0.3V$ $U_{max} = 0...30V$ Short-circuit-proof against DGND
7	N.C.				Not connected
8	N.C.				Not connected
9	VMON	AO	Actual value: voltage	0...10V or 0...5V correspond to 0..100% of U_{nom}	Accuracy < 0.2% at $I_{max} = +2mA$ Short-circuit-proof against AGND
10	CMON	AO	Actual value: current	0...10V or 0...5V correspond to 0..100% of I_{nom}	
11	AGND	POT	Reference potential for analogue signals		For -SEL, -MON, VREF signals
12	+Vcc	AO	Auxiliary voltage output (Ref: DGND)	11...13V	$I_{max} = 20mA$ Short-circuit-proof against DGND
13	REM-SB	DI	Output off	off = LOW, $U_{low} < 1V$ on = HIGH, $U_{high} > 4V$ on = OPEN	U range = 0 ...30V $I_{max} = +1mA$ at 5V Sender: Open-Collector against DGND
14	OVP	DO	Overvoltage error	OVP = HIGH, $U_{high} > 4V$ no OVP = LOW, $U_{low} < 1V$	Quasi open collector with pull-up to Vcc ** At 5V at the output there will be max.+1mA $I_{max} = -10mA$ at $U_{ce} = 0.3V$ $U_{max} = 0...30V$ Short-circuit-proof against DGND
15	CV	DO	Indication of voltage regulation active	CV = LOW, $U_{low} < 1V$ CC = HIGH, $U_{high} > 4V$	

* AI = Analogue input, AO = Analogue output, DI = Digital input, DO = Digital output, POT = Potential

** Internal Vcc = 13...15V

11. Miscellaneous

11.1 Accessories and options

Note: Details about options and accessories are available in separate user guides.

Following accessories are available:

a) USB-to-Analogue interface UTA12

Galvanically isolated remote control via USB (on PC side) and the device internal analogue interface.

b) Digital interface cards

Pluggable and retrofittable, digital interface cards for USB, RS232, CAN, GPIB/IEEE (SCPI only), Ethernet/LAN (SCPI) or Profibus are available. For details refer to the external user manual of the interface cards.

Following options are available:

a) HS: High Speed Ramping (only for models from 1kW)

Increased dynamics of the output voltage by reduced output capacity. This is a permanent modification which is not switchable.

11.2 Parallel connection

Parallel connection of (ideally) identical units is used to increase the output current. For a parallel connection, all positive DC outputs are connected to each other and all negative DC outputs to each other.

There are several ways to realise a parallel connection:

a) The units are connected to each other in a kind of master-slave operation by wiring the analogue interfaces from unit to unit. Also see „10.2 Example applications“. Here the master will control all slave or only the next slave which will be the master of the next one etc. The unit which was assigned as master could additionally be monitored and remote controlled by a digital interface card. There will be no total formation on the master.

Advantages: symmetric load distribution, master monitorisable, actual values from the master can be multiplied with the number of (identical) units, no external analogue control unit required

Disadvantages: in case the wiring is done so that one unit is the master of the next unit and a slave drops out because of an error, the rest of the chain will no longer provide power output; the same applies for the whole system, if the master drops out.

b) An external control unit, for example a PLC, provides the required analogue set values and controls every unit separately. The units are only connected in parallel with their DC outputs.

Advantages: better supervision of the single units, if one unit fails the other will continue to work without interruption (redundancy)

Disadvantages: extra hardware required, long signal lines which will be susceptible for glitches and HF interference, symmetric load distribution not guaranteed, no master-slave

11.3 Series connection

A series connection of power supplies with identical or different maximum output voltage and (ideally) identical maximum output current is used to gain a higher total voltage.

In this connection, the unit with the smallest output current will determine the maximum current of the whole setup.



Attention!

- **The analogue interfaces must not be connected between the units**
- **No master-slave connection possible. Every unit has to be controlled separately**
- **In case one of the DC output poles is grounded, it is for safety reasons only allowed to ground the output with the lowest potential against ground, in this case DC minus (-)**
- **The total allowed DC output voltage of a series connection is 600V and must not be exceeded**

11.4 Firmware update

A firmware update of the device should only be done if the device shows erroneous behaviour and there is an update available or if new features have been implemented.

In order to update a device, it requires a certain digital interface card, a new firmware file and a Windows software called „Update tool“.

These interfaces are qualified to be used for a firmware update:

- IF-U1 (USB)
- IF-R1 (RS232)
- IF-E1 (Ethernet/USB)
- IF-PB1 (Profibus/USB)

In case none of the above interface types is at hand, the device can not be updated. Please contact your dealer for a solution.

The update tool and the particular firmware file for your device can be obtained from the website of the device manufacturer or are mailed upon request. The update tool will guide the user through the semi-automatic update process.



Elektro-Automatik

EA-Elektro-Automatik GmbH & Co. KG

研发 - 生产 - 销售

Development - Production - Sales

Helmholtzstraße 31-33

41747 Viersen

Germany

Tel: +49 2162 / 37 85-0

Fax: +49 2162 / 16 230

ea1974@elektroautomatik.de

www.elektroautomatik.cn